



**MAX**<sup>®</sup>  
PROFESSIONAL

**Surgical  
Instruments**

# Diagnostics



**BIS-001**  
Taylor Percussion Hammer  
18cm

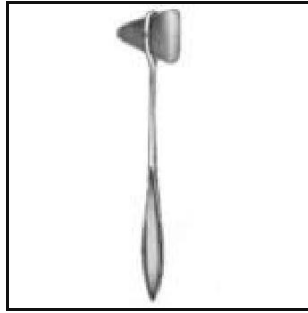

**BIS-002**  
Taylor Percussion Hammer  
20cm



**BIS-003**  
Dejerine Percussion Hammer  
20cm



**BIS-004**  
Dejerine Percussion Hammer  
w/needle 21cm



**BIS-005**  
Troemner Percussion w/loope  
handle 24cm

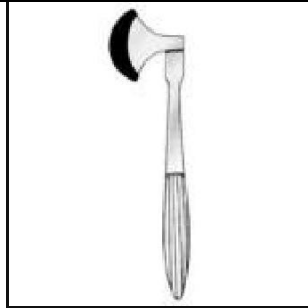

**BIS-006**  
Berliner Percussion Hammer  
17cm

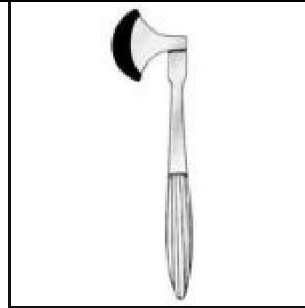

**BIS-007**  
Berliner Percussion Hammer  
20cm



**BIS-008**  
Buck Neurological Percussion  
Hammer 18cm



**BIS-009**  
Babinsky Percussion Hammer  
22cm



**BIS-010**  
Babinsky Percussion Hammer  
25cm



**BIS-011**  
Rabiner Percussion Hammer  
23cm



**BIS-012**  
Pinard Stethoscope Plastic  
15cm

# Scalpels



**BIS-013**  
Scalpel Metal Handle Fig.1



**BIS-014**  
Scalpel Metal Handle Fig.2

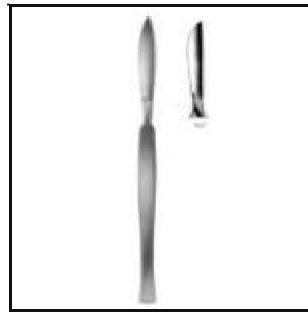

**BIS-015**  
Scalpel Metal Handle Fig.3



**BIS-016**  
Scalpel Metal Handle Fig.4



**BIS-017**  
Scalpel Metal Handle Fig.5

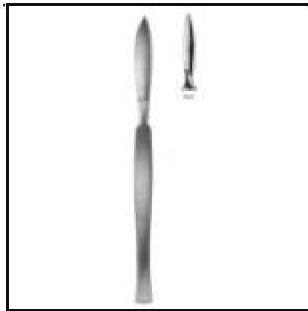

**BIS-018**  
Scalpel Metal Handle Fig.6

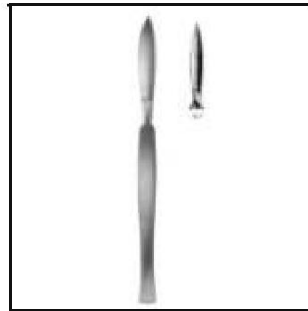

**BIS-019**  
Scalpel Metal Handle Fig.7



**BIS-020**  
Scalpel Metal Handle Fig.8



**BIS-021**  
Scalpel Metal Handle Fig.9



**BIS-022**  
Scalpel Metal Handle Fig.10

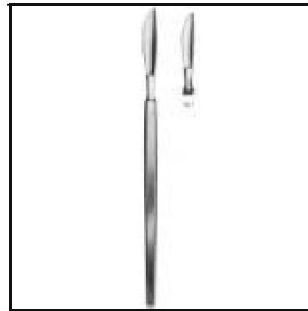

**BIS-023**  
Dieffenbach Scalpel Metal  
Handle 16cm Fig.1

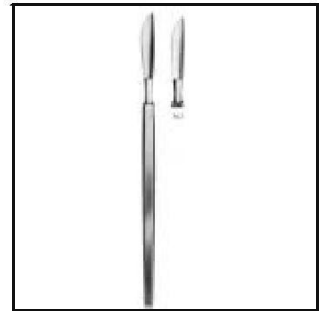

**BIS-024**  
Dieffenbach Scalpel Metal  
Handle 16cm Fig.2



**BIS-025**  
Atopsy Knife 25.5cm



**BIS-026**  
Walb Post Mortem Knife  
11cm



**BIS-027**  
Walb Post Mortem Knife  
14cm

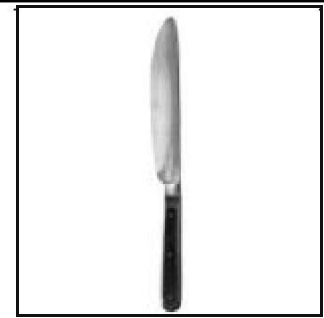

**BIS-028**  
Walb Post Mortem Knife  
17cm



**BIS-029**  
Virchow Brain Knife hollow  
handle 16cm

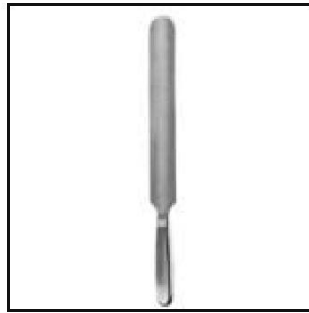

**BIS-030**  
Virchow Brain Knife hollow  
handle 20cm

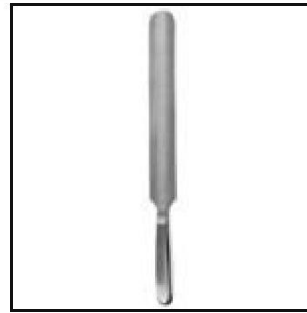

**BIS-031**  
Virchow Brain Knife hollow  
handle 24cm

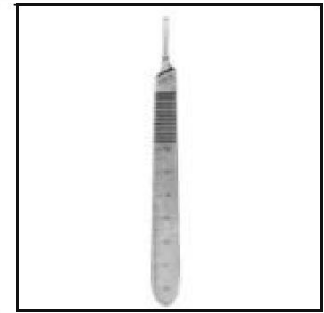

**BIS-032**  
Scalpel Handle #3 graduated  
in centimeters

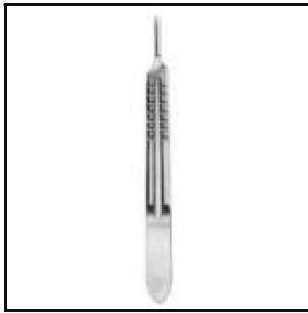

**BIS-033**  
Scalpel Handle grooved type  
#3

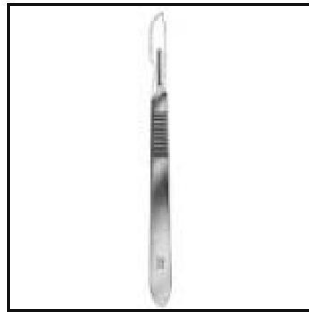

**BIS-034**  
Scalpel Handle #3

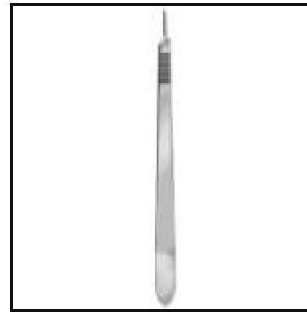

**BIS-035**  
Scalpel Handle #3L

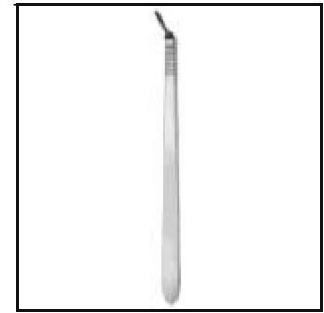

**BIS-036**  
Scalpel Handle #3L angled



**BIS-037**  
Scalpel Handle #4

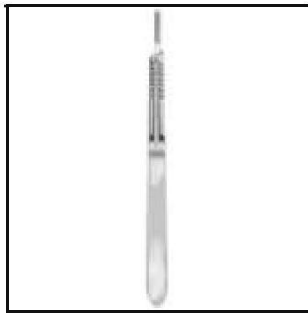

**BIS-038**  
Scalpel Handle #4L

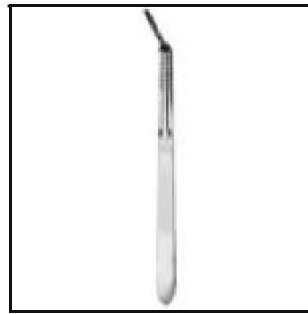

**BIS-039**  
Scalpel Handle #4L angled



**BIS-04**  
Scalpel Handle #3 round handle



**BIS-041**  
Scalpel Handle #7

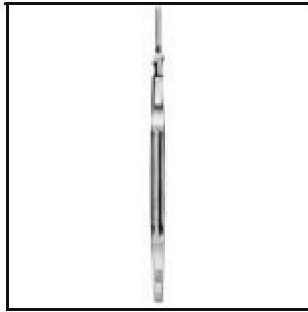

**BIS-042**  
Scalpel Handle Special Model #7K

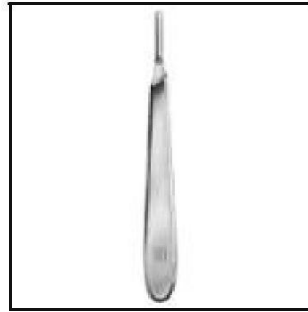

**BIS-043**  
Collin Scalpel Handle #8



**BIS-044**  
Collin Scalpel Handle #9

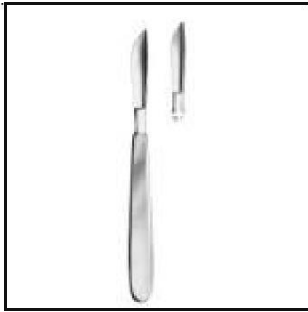

**BIS-045**  
Collin Operating Knife Fig.1

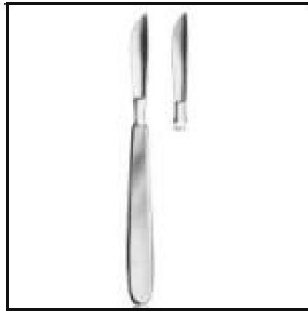

**BIS-046**  
Collin Operating Knife Fig.2

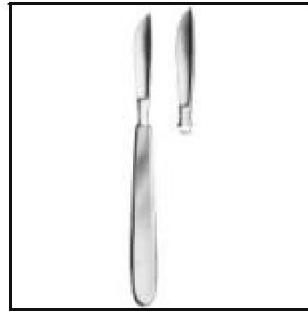

**BIS-047**  
Collin Operating Knife Fig.3

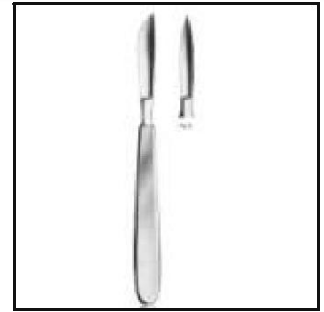

**BIS-048**  
Collin Operating Knife Fig.4

# Scissors



**BIS-049**  
Op-Scissors bl/bl str 11.5cm

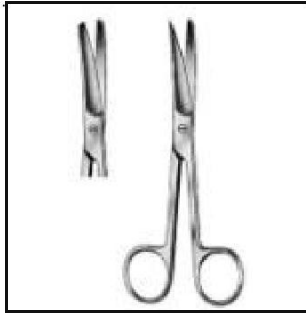

**BIS-050**  
Op-Scissors bl/bl cvd 11.5cm



**BIS-051**  
Op-Scissors bl/bl str 13.0cm



**BIS-052**  
Op-Scissors bl/bl cvd 13.0cm



**BIS-053**  
Op-Scissors bl/bl str 14.5cm

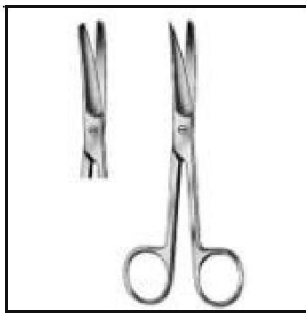

**BIS-054**  
Op-Scissors bl/bl cvd 14.5cm



**BIS-055**  
Op-Scissors bl/bl str 16.5cm



**BIS-056**  
Op-Scissors bl/bl cvd 16.5cm



**BIS-057**  
Op-Scissors bl/bl str 18.5cm

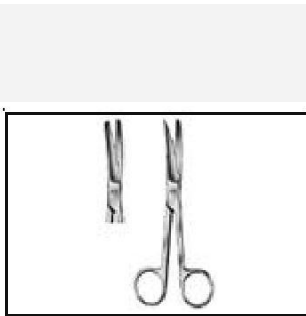

**BIS-058**  
Op-Scissors bl/bl cvd 18.5cm



**BIS-059**  
Op-Scissors sh/bl str 11.5cm



**BIS-060**  
Op-Scissors sh/bl cvd 11.5cm

# Scissors



**BIS-061**  
Op-Scissors sh/bl str 13.0cm



**BIS-062**  
Op-Scissors sh/bl cvd 13.0cm



**BIS-063**  
Op-Scissors sh/bl str 14.5cm



**BIS-064**  
Op-Scissors sh/bl cvd 14.5cm



**BIS-065**  
Op-Scissors sh/bl str 16.5cm



**BIS-066**  
Op-Scissors sh/bl cvd 16.5cm



**BIS-061**  
Op-Scissors sh/bl str 18.5cm



**BIS-062**  
Op-Scissors sh/bl cvd 18.5cm



**BIS-063**  
Op-Scissors sh/sh str 11.5cm



**BIS-064**  
Op-Scissors sh/sh cvd 11.5cm



**BIS-065**  
Op-Scissors sh/sh str 13cm



**BIS-066**  
Op-Scissors sh/sh cvd 13cm

# Scissors



**BIS-067**  
Op-Scissors sh/sh str 14.5cm



**BIS-068**  
Op-Scissors sh/sh cvd  
14.5cm

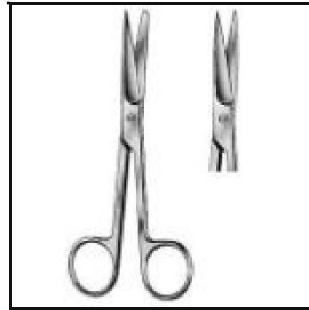

**BIS-069**  
Op-Scissors sh/sh str 16.5cm



**BIS-070**  
Op-Scissors sh/sh cvd  
16.5cm



**BIS-071**  
Op-Scissors sh/sh str 18.5cm



**BIS-072**  
Op-Scissors sh/sh cvd  
18.5cm



**BIS-073**  
Deaver Scissors str bl/bl  
18cm



**BIS-074**  
Deaver Scissors cvd bl/bl  
14cm



**BIS-075**  
Deaver Scissors str sh/bl  
14cm



**UE BIS-076**  
Deaver Scissors cvd sh/bl  
14cm



**BIS-077**  
Deaver Scissors str sh/sh  
14cm



**BIS-078**  
Deaver Scissors cvd sh/sh  
14cm



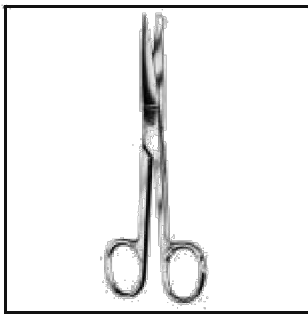

**BIS-079**  
Incision Scissors w/probe str  
13cm

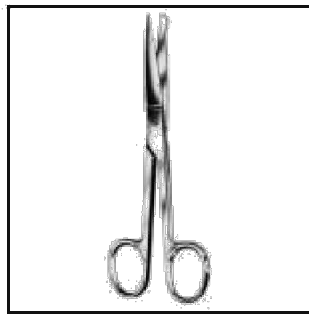

**BIS-080**  
Incision Scissors w/probe str  
14cm

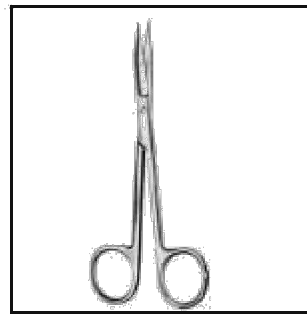

**BIS-081**  
GOLDMAN-FOX Gum  
Scissors str 13cm

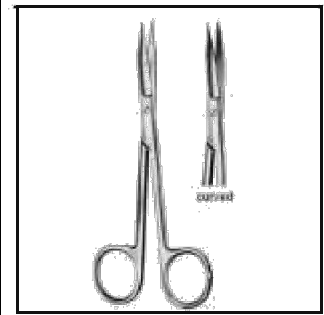

**BIS-082**  
GOLDMAN-FOX Gum  
Scissors cvd 13cm



**BIS-083**  
Mixer Scissors bl/bl str  
15.5cm



**BIS-084**  
Mixer Scissors bl/bl cvd  
15.5cm

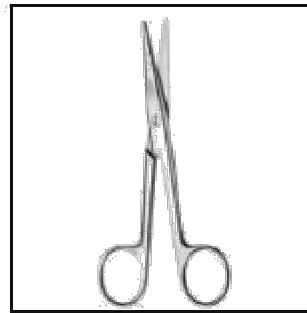

**BIS-085**  
Mayo Stille Scissors str  
14.5cm

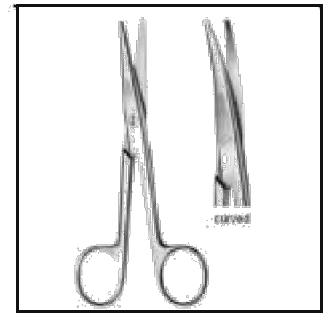

**BIS-086**  
Mayo Stille Scissors cvd  
14.5cm

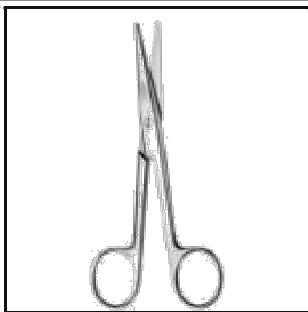

**BIS-087**  
Mayo Stille Scissors str 17cm

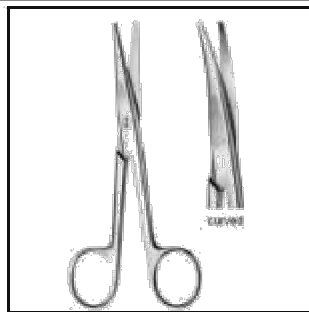

**BIS-088**  
Mayo Stille Scissors cvd  
17cm



**BIS-089**  
Mayo Scissors str 14.5cm

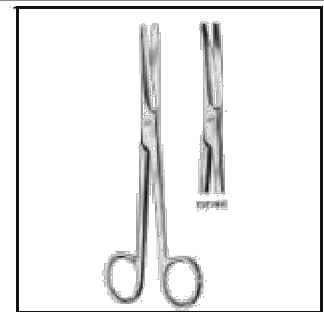

**BIS-090**  
Mayo Scissors cvd 14.5cm

# Scissors



**BIS-091**  
Mayo Scissors str 17cm



**BIS-092**  
Mayo Scissors cvd 17cm



**BIS-093**  
Mayo Scissors str 23cm



**BIS-094**  
Mayo Scissors cvd 23cm



**BIS-095**  
Mayo Harrington Operating  
Scissors str 22.5cm

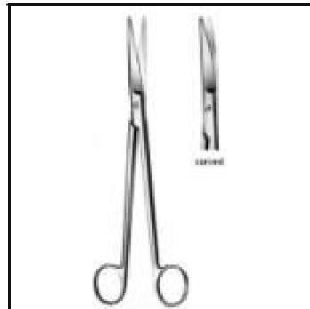

**BIS-096**  
Mayo Harrington Operating  
Scissors cvd 22.5cm

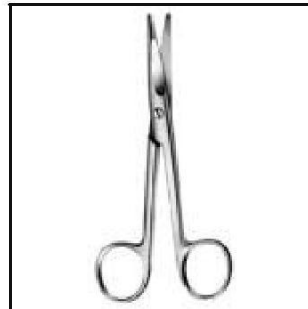

**BIS-097**  
Mayo Diss. Scissors str  
bevelled blade 14cm



**BIS-098**  
Mayo Diss. Scissors cvd  
bevelled blade 14cm



**BIS-099**  
Mayo Diss. Scissors str  
bevelled blade 17cm

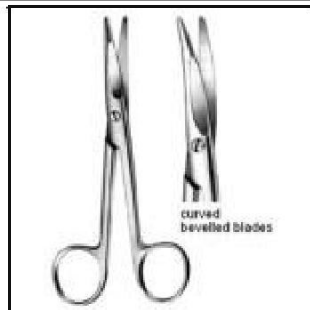

**BIS-100**  
Mayo Diss. Scissors cvd  
bevelled blade 17cm



**BIS-101**  
Mayo Diss. Scissors str  
bevelled blade 19cm

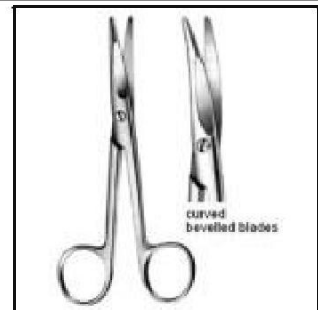

**BIS-102**  
Mayo Diss. Scissors cvd  
bevelled blade 19cm

# Scissors



**BIS-103**  
Mayo Diss. Scissors str  
bevelled blade 21.5cm



**BIS-104**  
Mayo Diss. Scissors cvd  
bevelled blade 21.5cm



**BIS-105**  
Mayo Stille Scissors str 15cm



**BIS-106**  
Mayo Stille Scissors cvd  
15cm



**BIS-107**  
Mayo Stille Scissors str 17cm

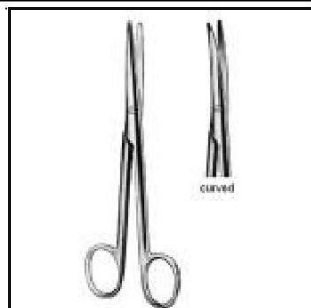

**BIS-108**  
Mayo Stille Scissors cvd  
17cm



**BIS-109**  
Mayo Stille Scissors str 19cm



**BIS-110**  
Mayo Stille Scissors cvd  
19cm



**BIS-111**  
Mayo Stille Scissors str 21cm



**BIS-112**  
Mayo Stille Scissors cvd  
21cm



**BIS-113**  
Mayo Noble Scissors str  
17cm



**BIS-114**  
Mayo Noble Scissors cvd  
17cm

# Scissors



**BIS-115**  
Metzenbaum Scissors bl/bl str  
14.5cm



**BIS-116**  
Metzenbaum Scissors bl/bl  
cvd 14.5cm



**BIS-117**  
Metzenbaum Scissors sh/bl str  
14.5cm



**BIS-118**  
Metzenbaum Scissors sh/bl  
cvd 14.5cm



**BIS-119**  
Metzenbaum Scissors sh/sh  
str 14.5cm



**BIS-120**  
Metzenbaum Scissors sh/sh  
cvd 14.5cm



**BIS-121**  
Metzenbaum Scissors str  
11.5cm



**BIS-122**  
Metzenbaum Scissors cvd  
11.5cm



**BIS-123**  
Metzenbaum Scissors str  
18cm



**BIS-124**  
Metzenbaum Nelson Scissors  
cvd 18cm



**BIS-125**  
Metzenbaum Scissors str  
20cm



**BIS-126**  
Metzenbaum Nelson Scissors  
cvd 20cm

# Scissors



**BIS-127**  
Metzenbaum Nelson Scissors  
str 23cm



**BIS-128**  
Metzenbaum Nelson Scissors  
cvd 23cm



**BIS-129**  
Metzenbaum Scissors str  
25cm



**BIS-130**  
Metzenbaum Nelson Scissors  
bl/bl cvd 25cm



**BIS-131**  
Metzenbaum Scissors str  
28cm



**BIS-132**  
Metzenbaum Nelson Scissors  
cvd 28cm



**BIS-133**  
Metzenbaum Nelson Scissors  
sh/bl str 18cm



**BIS-134**  
Metzenbaum Nelson Scissors  
sh/bl cvd 18cm



**BIS-135**  
Metzenbaum Nelson Scissors  
sh/bl str 20cm



**BIS-136**  
Metzenbaum Nelson Scissors  
sh/bl cvd 20cm



**BIS-137**  
Metzenbaum Nelson Scissors  
sh/bl str 23cm



**BIS-138**  
Metzenbaum Nelson Scissors  
sh/bl cvd 23cm

# Scissors



**BIS-139**  
Reynolds Fine Op-Scissors  
cvd 18cm



**BIS-140**  
JOSEPH Plastic Scissors str  
14cm



**BIS-141**  
JOSEPH Plastic Scissors cvd  
14cm

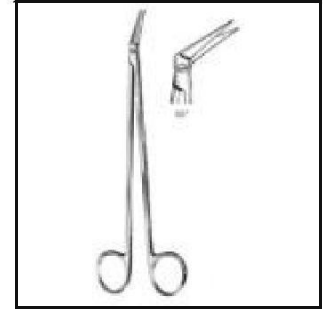

**BIS-142**  
POTTS-SMITH Vascular  
Scissors 60°, 19cm

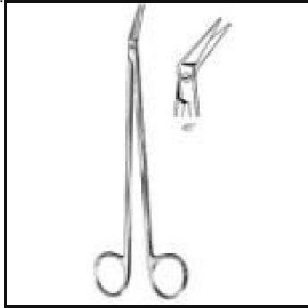

**BIS-143**  
POTTS-SMITH Vascular  
Scissors 40°, 19cm



**BIS-144**  
POTTS-SMITH Vascular  
Scissors 25°, 19cm



**BIS-145**  
HEYMANN Nasal  
Turbinectomy Scissors 18cm

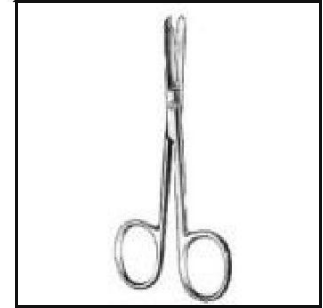

**BIS-146**  
Spencer Stitch Scissors 9cm



**BIS-147**  
Spencer Stitch Scissors 11cm



**BIS-148**  
Spencer Stitch Scissors 13cm



**BIS-149**  
LITTAUER Ligature Scissors  
14cm

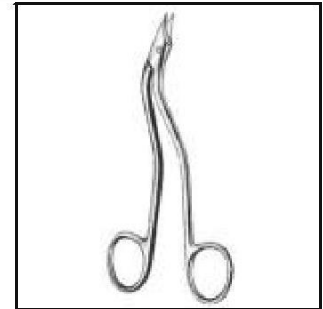

**BIS-150**  
HEATH Ligature Scissors  
15cm

# Scissors



**BIS-151**  
Schoemaker Loth Ligature  
Scissors 13cm

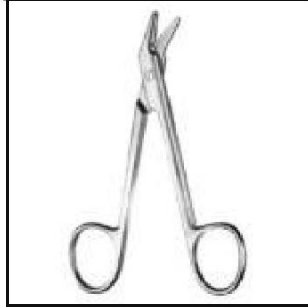

**BIS-152**  
Universal Wire Scissors Serr  
12cm



**BIS-153**  
Beebee Scissors blunt str  
10cm



**BIS-154**  
Beebee Scissors blunt cvd  
10cm



**BIS-155**  
Beebee Scissors sh/sh str  
10cm



**BIS-156**  
Beebee Scissors sh/sh cvd  
10cm

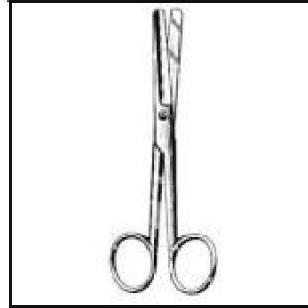

**BIS-157**  
Busch Umbilical Scissors bl/bl  
str 16cm



**BIS-158**  
Busch Umbilical Cord Scissors  
13.5cm

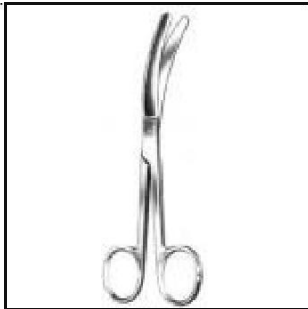

**BIS-159**  
Busch Umbilical Cord Scissors  
16cm



**BIS-160**  
Waldmann Episiotomy  
Scissors 18cm



**BIS-161**  
Schumacher Umbilical Card  
Scissors 15.5cm



**BIS-162**  
U.S.A patt Umbilical Scissors  
10cm

# Scissors



**BIS-163**  
Neumann Gum Scissors S-  
cud 12cm



**BIS-164**  
BRAUN Stadler Episiotomy  
Scissors 14.5cm



**BIS-165**  
BRAUN Stadler Episiotomy  
Scissors 22cm



**BIS-166**  
Doyen Gynecological Scissors  
str sh/bl 16cm



**BIS-167**  
DOYEN Gynecological  
Scissors str 16cm



**BIS-168**  
DOYEN Gynecological  
Scissors cud 16cm



**BIS-169**  
DOYEN Gynecological  
Scissors str 17.5cm



**BIS-170**  
DOYEN Gynecological  
Scissors cud 17.5cm



**BIS-171**  
Vezién Gyne. & Abdominal  
Scissors cud 18cm

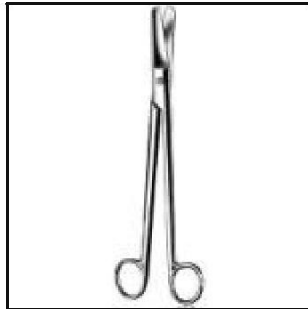

**BIS-172**  
DUBOIS Gynecological  
Scissors str 27cm



**BIS-173**  
DUBOIS Gynecological  
Scissors cud 27cm

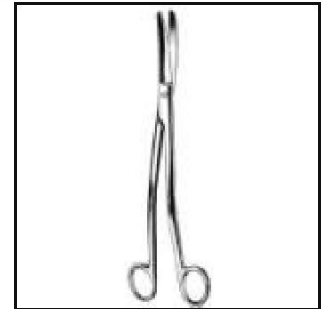

**BIS-174**  
Siebold Gynecological  
Scissors S/cud 24cm



# Scissors

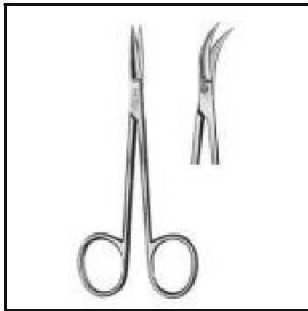

**BIS-175**  
Iris Scissors cvd to side  
11.5cm



**BIS-176**  
Iris Scissors angled to side  
11.5cm



**BIS-177**  
STEVENS Tenotomy Scissors  
sh/sh str 11cm



**BIS-178**  
STEVENS Tenotomy Scissors  
sh/sh cvd 11cm



**BIS-179**  
STEVENS Tenotomy Scissors  
str bl/bl 11cm



**BIS-180**  
STEVENS Tenotomy Scissors  
cvd bl/bl 11cm

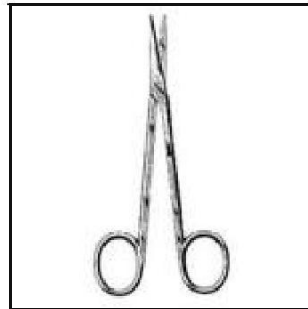

**BIS-181**  
Strabismus Scissors str  
11.5cm



**BIS-182**  
Strabismus Scissors cvd  
11.5cm

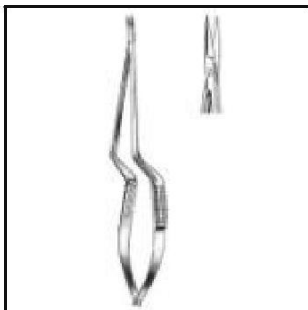

**BIS-183**  
Micro Scissors str bayonet  
18.5cm

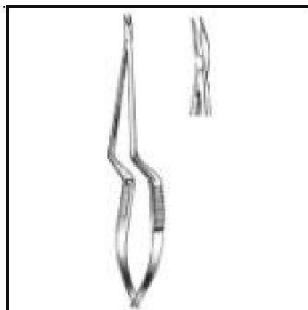

**BIS-184**  
Micro Scissors cvd bayonet  
18.5cm

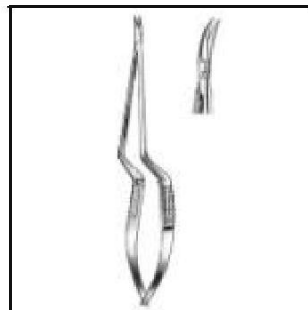

**BIS-185**  
Micro Scissors cvd downward  
bayonet 18.5cm

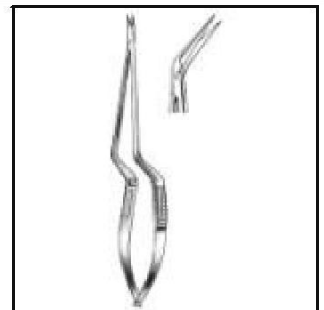

**BIS-186**  
Nagel Micro Scissors ang.  
bayonet 18.5cm

# Scissors

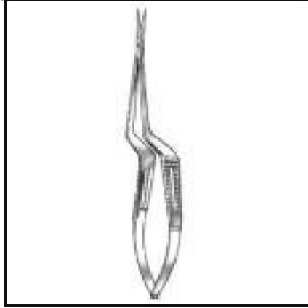

**BIS-187**  
Micro Scissor str bayonet  
15.5cm

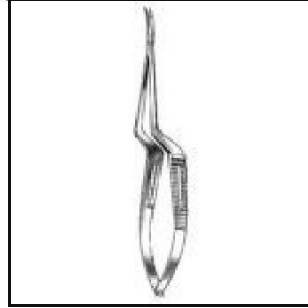

**BIS-188**  
Micro Scissor cvd bayonet  
15.5cm

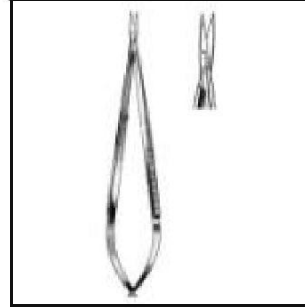

**BIS-189**  
Micro Scissors str spring  
action 18.5cm

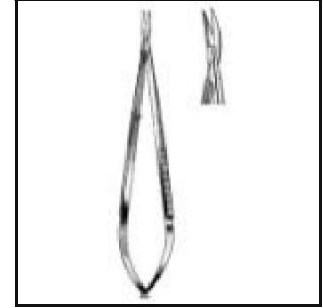

**BIS-190**  
Micro Scissors cvd spring  
action 18.5cm

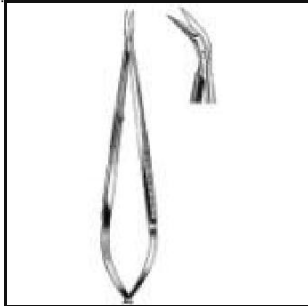

**BIS-191**  
Micro Scissors angled spring  
action 18.5cm

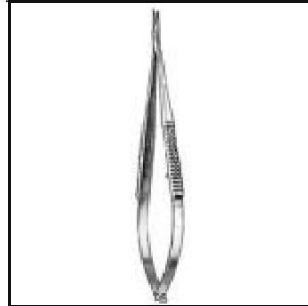

**BIS-192**  
Reill Micro Scissor str 14cm

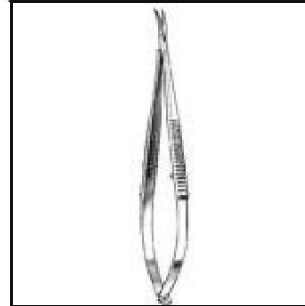

**BIS-193**  
Reill Micro Scissor cvd  
15.5cm

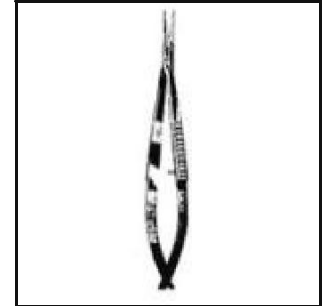

**BIS-194**  
McClure Micro Spring Scissor  
str sh/sh 9cm



**BIS-195**  
Micro Spring Scissor angular  
9cm

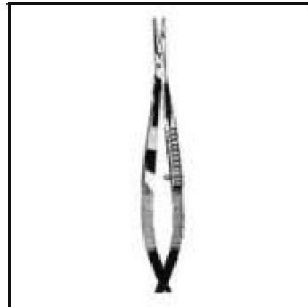

**BIS-196**  
Micro Spring Scissors bl/bl str  
9cm

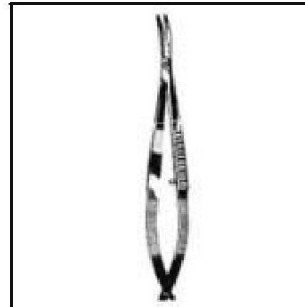

**BIS-197**  
Micro Spring Scissors bl/bl cvd  
9cm

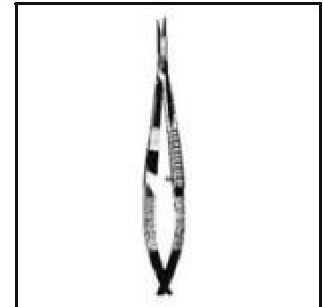

**BIS-198**  
Micro Spring Scissors one  
probe end 9cm

# Scissors

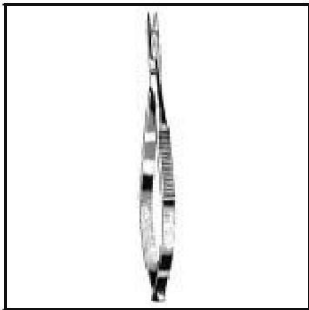

**BIS-199**  
Westcott Spring Scissors  
sh/sh str 11.5cm

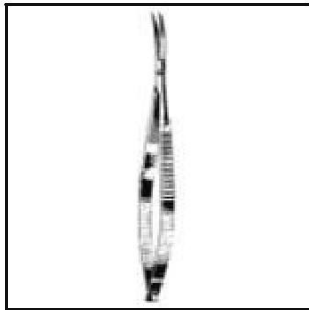

**BIS-200**  
Westcott Spring Scissors cvd  
sharp 11.5cm

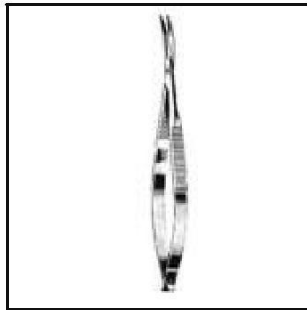

**BIS-201**  
Micro Spring Scissors cvd  
11cm

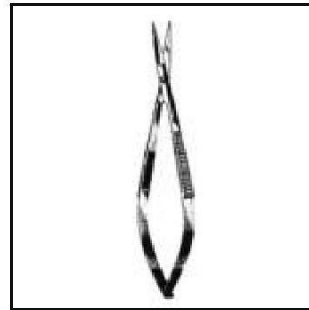

**BIS-202**  
Micro Spring Scissors str  
12cm



**BIS-203**  
Op-Scissors bl/bl str 14.5cm  
TC



**BIS-204**  
Op-Scissors bl/bl cvd 14.5cm  
TC



**BIS-205**  
Op-Scissors bl/bl str 16.5cm  
TC



**BIS-206**  
Op-Scissors bl/bl cvd 16.5cm  
TC



**BIS-207**  
Op-Scissors bl/bl str 18.5cm  
TC



**BIS-208**  
Op-Scissors bl/bl cvd 18.5cm  
TC



**BIS-209**  
Op-Scissors sh/bl str 14.5cm  
TC



**BIS-210**  
Op-Scissors sh/bl cvd 14.5cm  
TC

# Scissors



**BIS-211**

Op-Scissors sh/bl str 16.5cm  
TC



**BIS-212**

Op-Scissors sh/bl cvd 16.5cm  
TC



**BIS-213**

Op-Scissors sh/bl str 18.5cm  
TC



**BIS-214**

Op-Scissors sh/bl cvd 18.5cm  
TC



**BIS-215**

Op-Scissors sh/sh str 14.5cm  
TC



**BIS-216**

Op-Scissors sh/sh cvd 14.5cm  
TC



**BIS-217**

Op-Scissors sh/sh str 16.5cm  
TC



**BIS-218**

Op-Scissors sh/sh cvd 16.5cm  
TC



**BIS-219**

Op-Scissors sh/sh str 18.5cm  
TC



**BIS-220**

Op-Scissors sh/sh cvd 18.5cm  
TC



**BIS-221**

Lexer Op-Scissors str 16cm  
TC



**BIS-222**

Lexer Op-Scissors cvd 16cm  
TC

# Scissors



**BIS-223**  
Mayo Scissors str 14.5cm TC

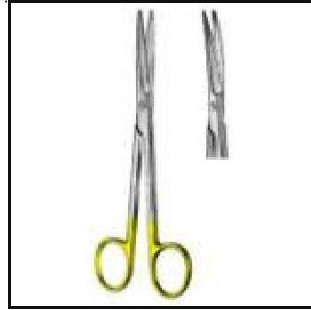

**BIS-224**  
Mayo Scissors cvd 14.5cm TC



**BIS-225**  
Mayo Scissors str 17cm TC

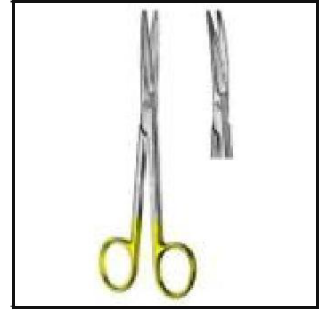

**BIS-226**  
Mayo Scissors cvd 17cm TC



**BIS-227**  
Mayo (Harrington) Scissors str  
23cm TC

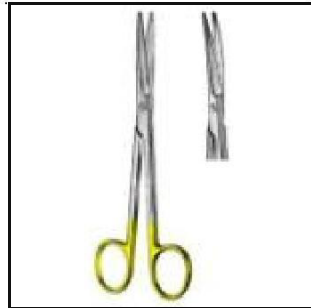

**BIS-228**  
Mayo (Harrington) Scissors  
cvd 23cm TC



**BIS-229**  
Mayo Stille Scissors str 15cm  
TC

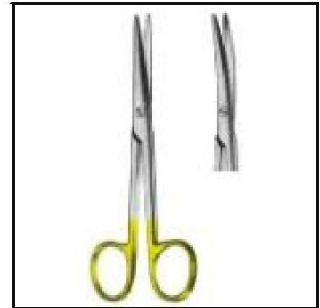

**BIS-230**  
Mayo Stille Scissors cvd 15cm  
TC



**BIS-231**  
Mayo Stille Scissors str 17cm  
TC



**BIS-232**  
Mayo Stille Scissors cvd 17cm  
TC



**BIS-233**  
Metzenbaum Scissors str  
14.5cm TC



**BIS-234**  
Metzenbaum Scissors cvd  
14.5cm TC

# Scissors



**BIS-235**  
Metzenbaum Scissors str  
18cm TC



**BIS-23**  
Metzenbaum Scissors cvd  
18cm TC



**BIS-237**  
Metzenbaum Scissors str  
20cm TC



**BIS-238**  
Metzenbaum Scissors cvd  
20cm TC



**BIS-239**  
Metzenbaum Scissors str  
23cm TC



**BIS-240**  
Metzenbaum Scissors cvd  
23cm TC



**BIS-241**  
Metzenbaum Scissors str  
25cm TC



**BIS-242**  
Metzenbaum Scissors cvd  
25cm TC



**BIS-243**  
Metzenbaum Scissors str  
28cm TC

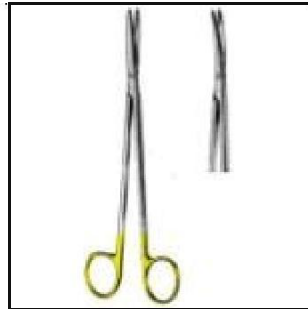

**BIS-244**  
Metzenbaum Scissors cvd  
28cm TC



**BIS-245**  
Metzenbaum Fino Scissors  
blunt str 14.5cm TC



**BIS-24**  
Metzenbaum Fino Scissors  
blunt cvd 14.5cm TC

# Scissors



**BIS-247**  
Metzenbaum Fino Scissors  
blunt str 18cm TC

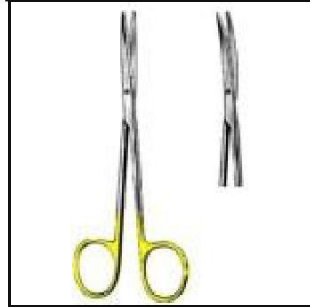

**BIS-248**  
Metzenbaum Fino Scissors  
blunt cvd 18cm TC



**BIS-249**  
Metzenbaum Fino Scissors  
blunt str 20cm TC



**BIS-250**  
Metzenbaum Fino Scissors  
blunt cvd 20cm TC



**BIS-251**  
Metzenbaum Fino Scissors  
blunt str 23cm TC



**BIS-252**  
Metzenbaum Fino Scissors  
blunt cvd 23cm TC



**BIS-253**  
Metzenbaum Fino Scissors  
blunt str 25cm TC



**BIS-254**  
Metzenbaum Fino Scissors  
blunt cvd 25cm TC



**BIS-255**  
Metzenbaum Deli Scissors  
sh/sh str 14.5cm TC



**BIS-256**  
Metzenbaum Deli Scissors  
sh/sh cvd 14.5cm TC



**BIS-257**  
Metzenbaum Deli Scissors  
sh/sh str 18cm TC



**BIS-258**  
Metzenbaum Deli Scissors  
sh/sh cvd 18cm TC

# Scissors



**BIS-259**  
Metzenbaum Deli.Scissors  
sh/sh str 20cm TC



**BIS-260**  
Metzenbaum Deli.Scissors  
sh/sh cvd 20cm TC



**BIS-261**  
Metzenbaum Deli.Scissors  
sh/sh str 23cm TC



**BIS-262**  
Metzenbaum Deli.Scissors  
sh/sh cvd 23cm TC



**BIS-263**  
Metzenbaum Fino Scissors  
sh/sh str 25cm TC



**BIS-264**  
Metzenbaum Fino Scissors  
sh/sh cvd 25cm TC



**BIS-265**  
Toennis Adson Scissors cvd  
17.5cm TC



**BIS-266**  
SIMS Uterine Scissors str  
23cm TC

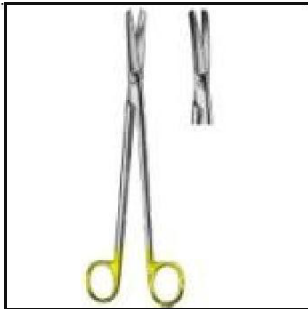

**BIS-267**  
SIMS Uterine Scissors cvd  
23cm TC



**BIS-268**  
Iris Scissors str 11.5cm TC



**BIS-269**  
Iris Scissors cvd 11.5cm TC



**BIS-270**  
Goldman Fox Scissors str  
13cm TC



# Scissors

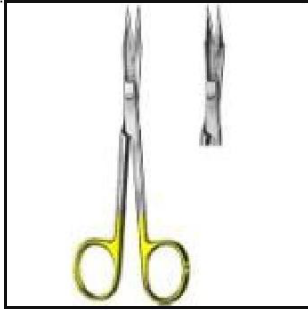

**BIS-271**  
Goldman Fox Scissors cvd  
13cm TC



**BIS-272**  
Lister Bandage Scissors 18cm  
TC



**BIS-273**  
DeBAKEY POTTS-SMITH  
vasc.Scissors 19cm 25ø TC



**BIS-274**  
DeBAKEY POTTS-SMITH  
vasc.Scissors 19cm 45ø TC

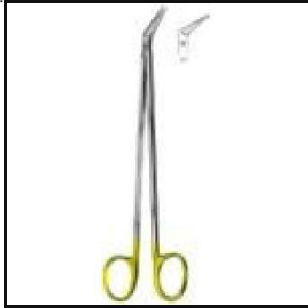

**BIS-275**  
DeBAKEY POTTS-SMITH  
vasc.Scissors 19cm 60ø TC



**BIS-276**  
DeBaKey Scissors 25ø 18cm  
TC

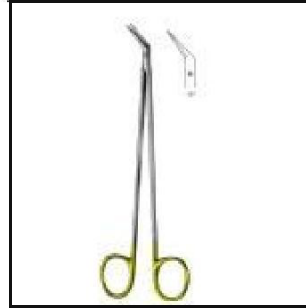

**BIS-277**  
DeBaKey Scissors 45ø 18cm  
TC



**BIS-278**  
DeBaKey Scissors 60ø 18cm  
TC



**BIS-279**  
Universal Wire Scissors 12cm  
TC

# Artery Forceps



**BIS-280**  
Hartmann Hemostatic Forceps  
str 10cm



**BIS-281**  
Hartmann Hemostatic Forceps  
cvd 10cm



**BIS-282**  
Carrel Hemostatic Forceps  
8.5cm



**BIS-283**  
Terrier Hemostatic Forceps  
1x2T 8.5cm



**BIS-284**  
Halstead Mosquito Forceps str  
12.5cm



**BIS-285**  
Halstead Mosquito Forceps  
cvd 12.5cm



**BIS-286**  
Halstead Mosquito Forceps str  
1x2T 12.5cm



**BIS-287**  
Halstead Mosquito Forceps  
cvd 1x2T 12.5cm

# Artery Forceps



**BIS-292**  
Halstead Micro Mosquito  
Forceps str 1x2T 10cm



**BIS-293**  
Halstead Micro Mosquito  
Forceps cvd 1x2T 10cm



**BIS-294**  
Halstead Micro Mosquito  
Forceps str 1x2T 12cm



**BIS-295**  
Halstead Micro Mosquito  
Forceps cvd 1x2T 12cm



**BIS-296**  
Halstead Mosquito Forceps str  
18cm



**BIS-297**  
Halstead Mosquito Forceps  
cvd 18cm



**BIS-298**  
Halstead Mosquito Forceps str  
1x2T 18cm

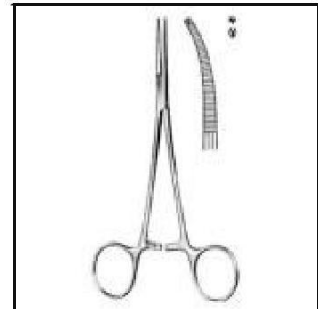

**BIS-299**  
Halstead Mosquito Forceps  
cvd 1x2T 18cm



**BIS-300**  
Halstead Mosquito Forceps str  
21cm



**BIS-301**  
Halstead Mosquito Forceps  
cvd 21cm



**BIS-302**  
Halstead Mosquito Forceps str  
1x2T 21cm

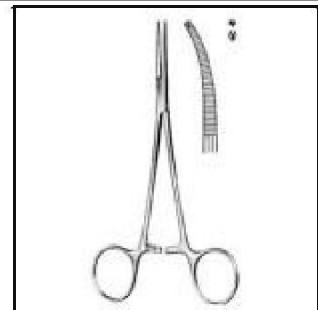

**BIS-303**  
Halstead Mosquito Forceps  
cvd 1x2T 21cm



**BIS-328**  
Kelly Hemostatic Forceps str  
14cm



**BIS-329**  
Kelly Hemostatic Forceps cvd  
14cm



**BIS-330**  
Crile Hemostatic Forceps str  
14cm



**BIS-331**  
Crile Hemostatic Forceps cvd  
14cm



**BIS-332**  
Crile Hemostatic Forceps str  
1x2T 14cm



**BIS-333**  
Crile Hemostatic Forceps cvd  
1x2T 14cm

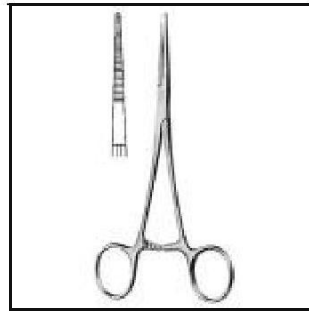

**BIS-334**  
Kelly Rankin Hemostatic  
Forceps str 16cm

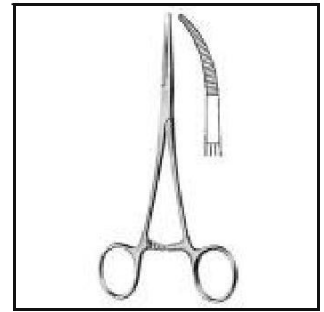

**BIS-335**  
Kelly Rankin Hemostatic  
Forceps cvd 16cm



**BIS-336**  
Crile Rankin Hemostatic  
Forceps str 16cm



**BIS-313**  
Crile Rankin Hemostatic  
Forceps cvd 16cm



**BIS-314**  
Lovlace Artery Forceps cross  
serr str 15.5cm



**BIS-315**  
Lovlace Hemostatic Forceps  
1x2T, 15.5cm

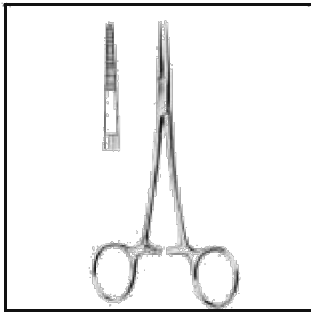

**BIS-316**  
Providence Hosp. Hemostatic  
Forceps str 14cm

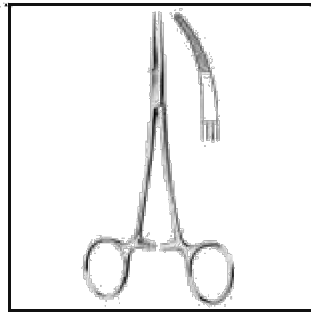

**BIS-317**  
Providence Hosp. Hemostatic  
Forceps cvd 14cm

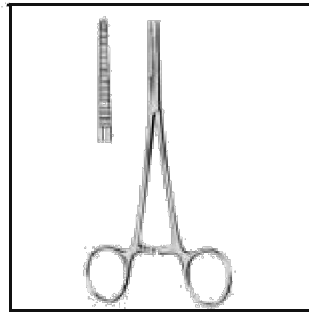

**BIS-318**  
Leriche Hemostatic Forceps  
str serr 15cm

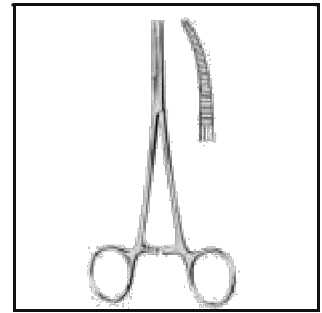

**BIS-319**  
Leriche Hemostatic Forceps  
cvd serr 15cm

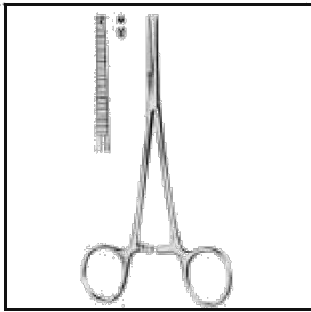

**BIS-320**  
Leriche Hemostatic Forceps  
str 1x2T 15cm

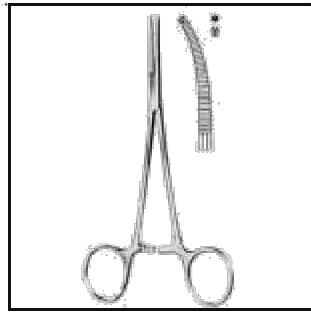

**BIS-321**  
Leriche Hemostatic Forceps  
cvd 1x2T 15cm

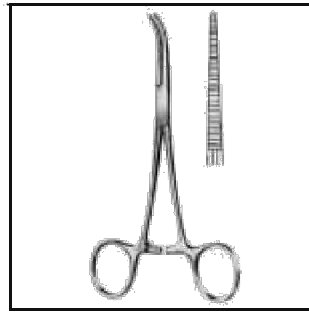

**BIS-322**  
Dandy Hemostatic Forceps  
cvd to side serr 14cm



**BIS-323**  
Dandy Hemostatic Forceps  
1x2T 14cm



**BIS-324**  
Bainbridge Hemostatic  
Forceps str 15cm



**BIS-325**  
Bainbridge Hemostatic  
Forceps cvd 15cm



**BIS-326**  
Bainbridge Hemostatic  
Forceps str 18.5cm



**BIS-327**  
Bainbridge Hemostatic  
Forceps cvd 18.5cm

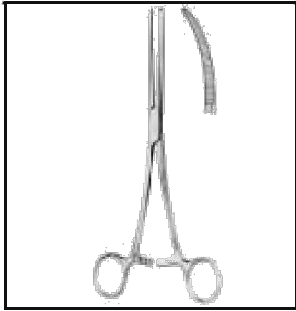

**BIS-329**  
Rochester Pean Hemostatic  
Forceps cvd 14cm

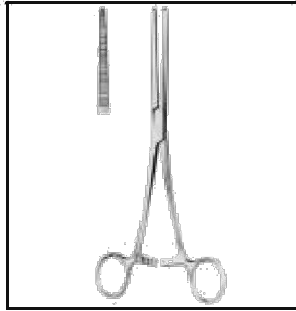

**BIS-330**  
Rochester Pean Hemostatic  
Forceps str 16cm

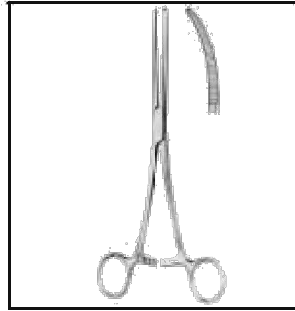

**BIS-331**  
Rochester Pean Hemostatic  
Forceps cvd 16cm

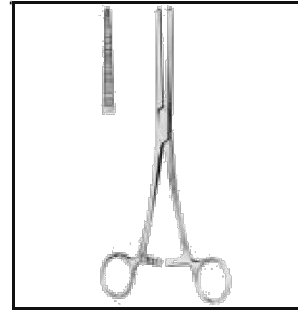

**BIS-332**  
Rochester Pean Hemostatic  
Forceps str 18cm

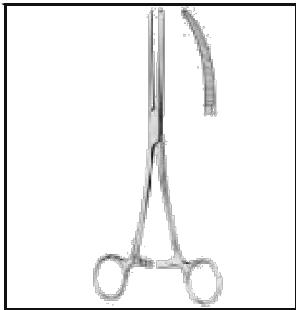

**BIS-333**  
Rochester Pean Hemostatic  
Forceps cvd 18cm

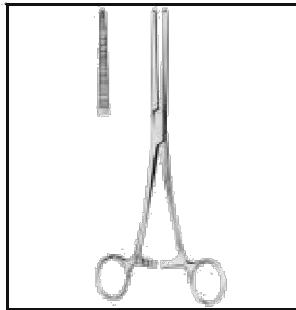

**BIS-334**  
Rochester Pean Hemostatic  
Forceps str 20cm

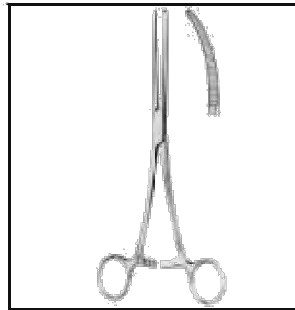

**BIS-335**  
Rochester Pean Hemostatic  
Forceps cvd 20cm

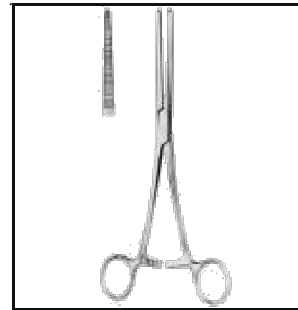

**BIS-336**  
Rochester Pean Hemostatic  
Forceps str 22cm

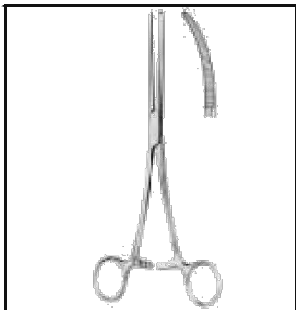

**BIS-337**  
Rochester Pean Hemostatic  
Forceps cvd 22cm

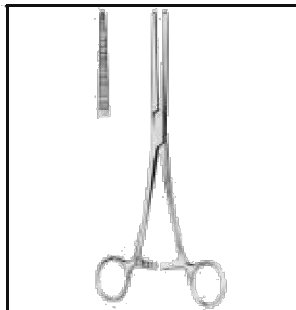

**BIS-338**  
Rochester Pean Hemostatic  
Forceps str 24cm

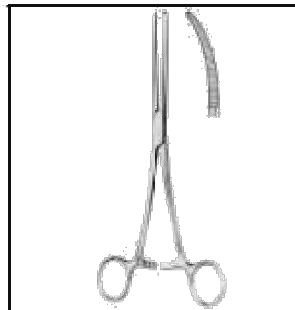

**BIS-339**  
Rochester Pean Hemostatic  
Forceps cvd 24cm

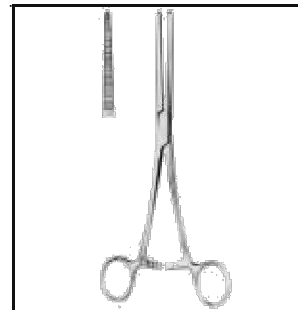

**BIS-340**  
Rochester Pean Hemostatic  
Forceps str 26cm

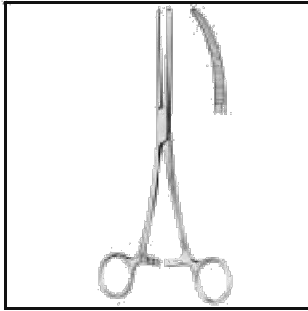

**BIS-341**  
Rochester Pean Hemostatic  
Forceps cvd 26cm



**BIS-342**  
Rochester Pean Hemostatic  
Forceps str 30cm

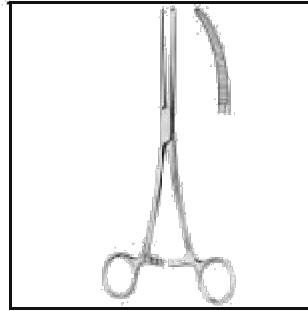

**BIS-343**  
Rochester Pean Hemostatic  
Forceps cvd 30cm

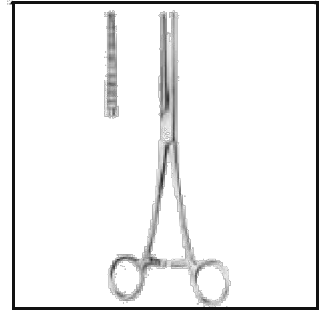

**BIS-344**  
Rochester Ochsner Forceps  
str 14cm

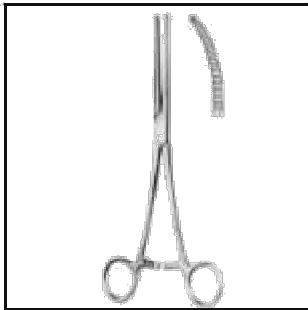

**BIS-345**  
Rochester Ochsner Forceps  
cvd 14cm

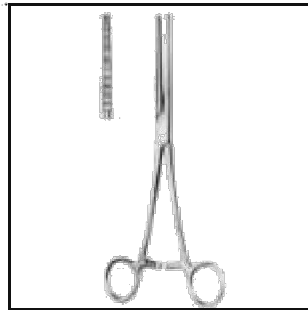

**BIS-346**  
Rochester Ochsner Forceps  
str 16cm

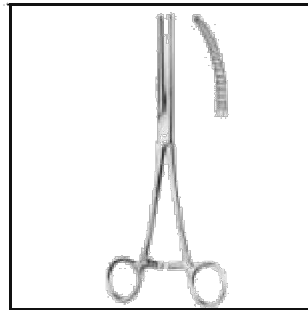

**BIS-347**  
Rochester Ochsner Forceps  
cvd 16cm

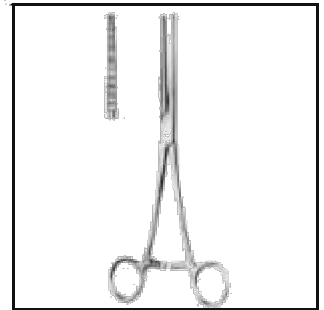

**BIS-348**  
Rochester Ochsner Forceps  
str 18cm

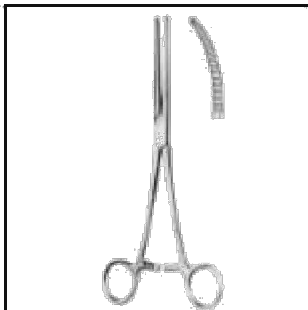

**BIS-349**  
Rochester Ochsner Forceps  
cvd 18cm

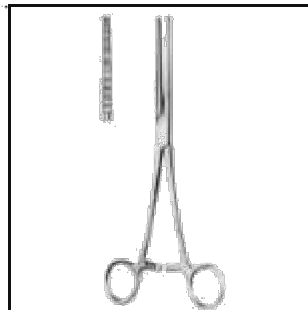

**BIS-350**  
Rochester Ochsner Forceps  
str 20cm

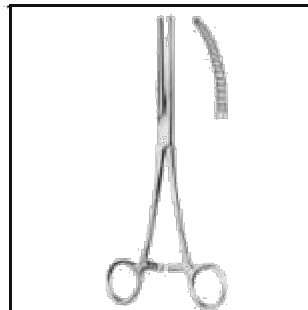

**BIS-351**  
Rochester Ochsner Forceps  
cvd 20cm

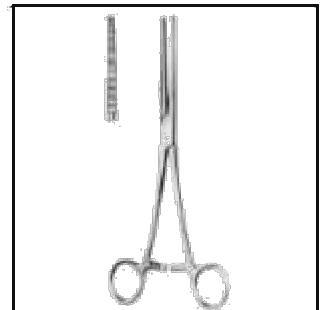

**BIS-352**  
Rochester Ochsner Forceps  
str 22cm

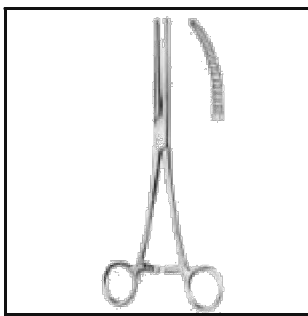

**BIS-353**  
Rochester Ochsner Forceps  
cvd 22cm

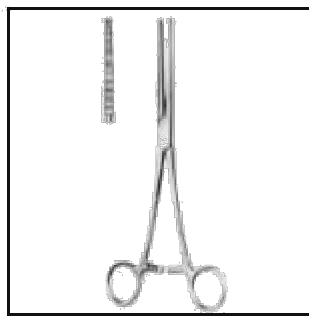

**BIS-354**  
Rochester Ochsner Forceps  
str 24cm

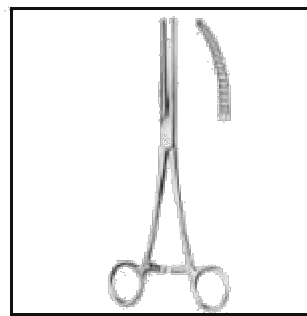

**BIS-355**  
Rochester Ochsner Forceps  
cvd 24cm

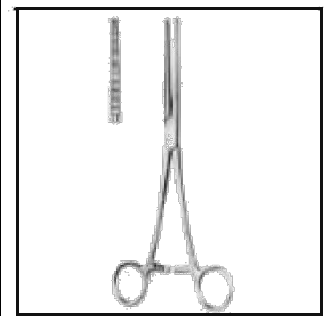

**BIS-356**  
Rochester Ochsner Forceps  
str 26cm

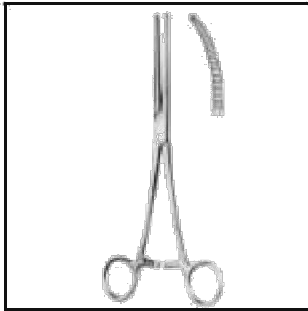

**BIS-357**  
Rochester Ochsner Forceps  
cvd 26cm

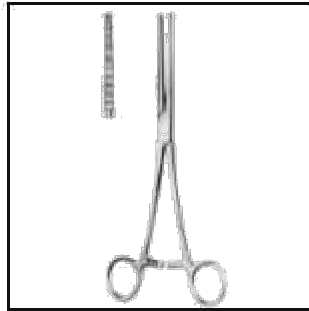

**BIS-358**  
Rochester Ochsner Forceps  
str 30cm

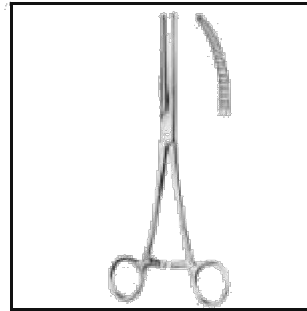

**BIS-359**  
Rochester Ochsner Forceps  
cvd 30cm



**BIS-360**  
Rochester Carmalt Hemostatic  
Forceps str 16cm



**BIS-361**  
Rochester Carmalt Hemostatic  
Forceps cvd 16cm



**BIS-362**  
Rochester Carmalt Hemostatic  
Forceps str 20cm

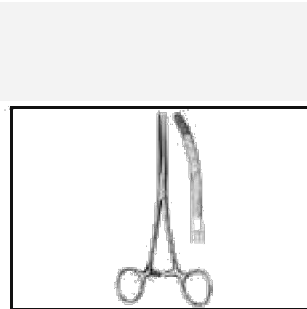

**BIS-363**  
Rochester Carmalt Hemostatic  
Forceps cvd 20cm

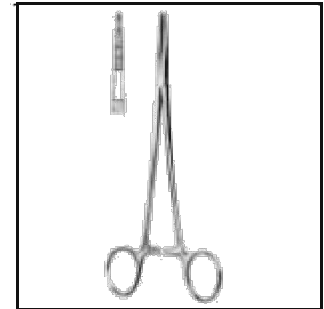

**BIS-364**  
Adson Hemostatic Forceps str  
18.5cm





**BIS-365**  
Spencerwells Artery Forceps  
S/J cvd 23cm

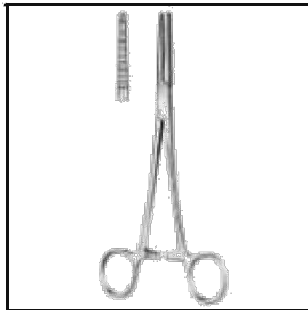

**BIS-366**  
Spencerwells Hemostatic  
Forceps str 13cm

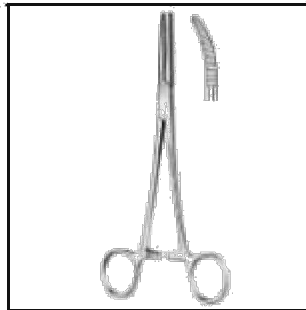

**BIS-367**  
Spencerwells Hemostatic  
Forceps cvd 13cm

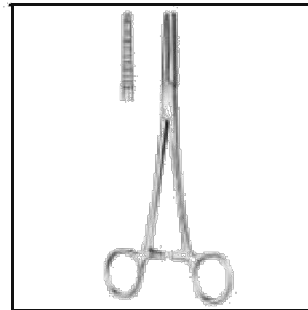

**BIS-368**  
Spencerwells Hemostatic  
Forceps str 15cm

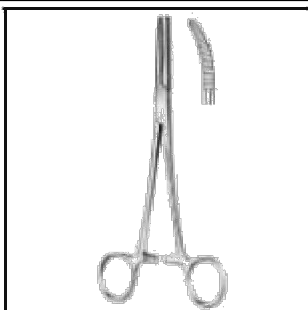

**BIS-369**  
Spencerwells Hemostatic  
Forceps cvd 15cm

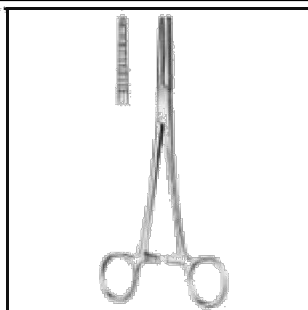

**BIS-370**  
Spencerwells Hemostatic  
Forceps str 18cm

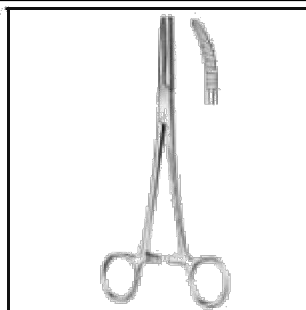

**BIS-371**  
Spencerwells Hemostatic  
Forceps cvd 18cm

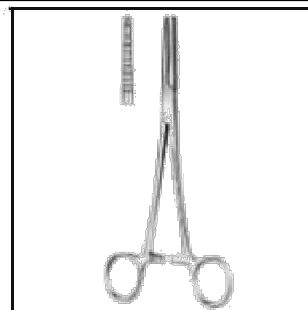

**BIS-372**  
Spencerwells Hemostatic  
Forceps str 20cm

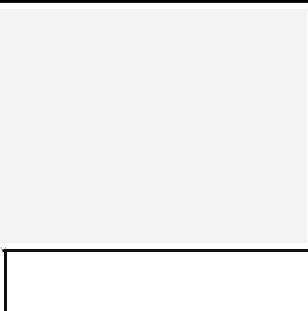

**BIS-373**  
Spencerwells Hemostatic  
Forceps cvd 20cm

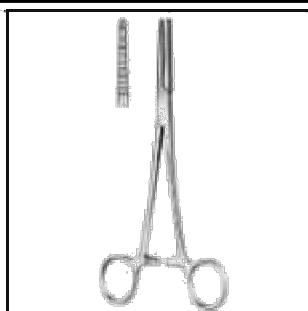

**BIS-374**  
Spencerwells Hemostatic  
Forceps str 23cm

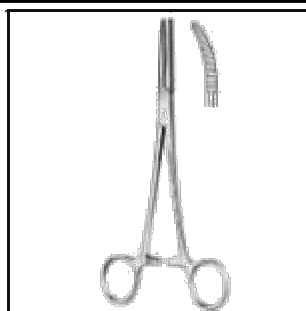

**BIS-375**  
Spencerwells Hemostatic  
Forceps cvd 23cm

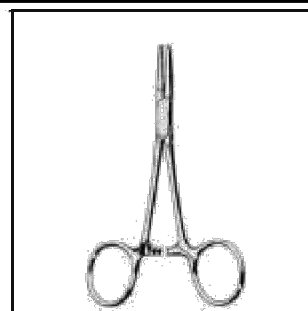

**BIS-376**  
Jones Artery Forceps str  
12.5cm

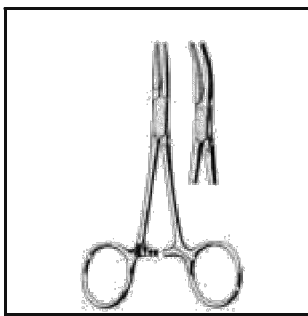

**BIS-377**  
Jones Artery Forceps cvd  
12.5cm

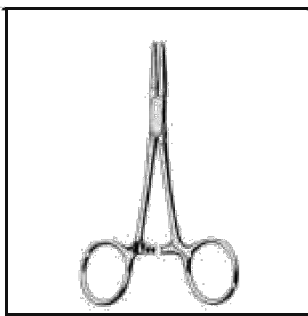

**BIS-378**  
Jones Artery Forceps str  
15cm

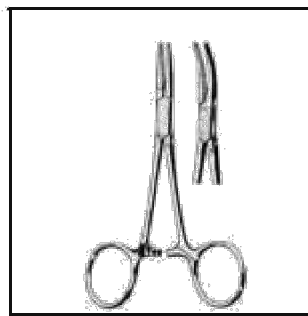

**BIS-379**  
Jones Artery Forceps cvd  
15cm

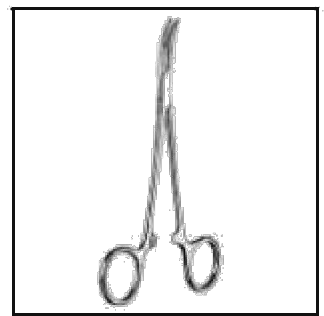

**BIS-380**  
Cairns Artery Forceps str  
14.5cm

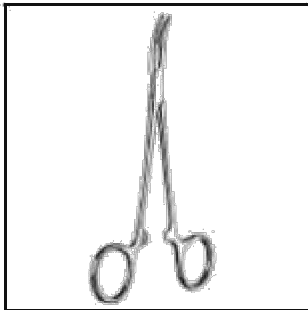

**BIS-381**  
Cairns Artery Forceps cvd  
14.5cm

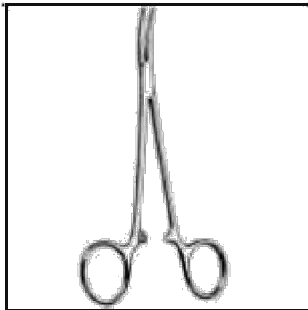

**BIS-382**  
Cushing Artery Forceps str  
14.5cm

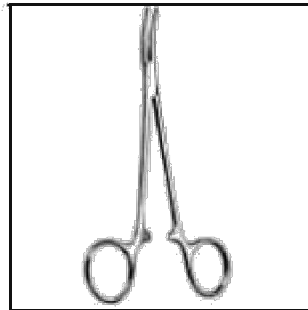

**BIS-383**  
Cushing Artery Forceps cvd  
14.5cm

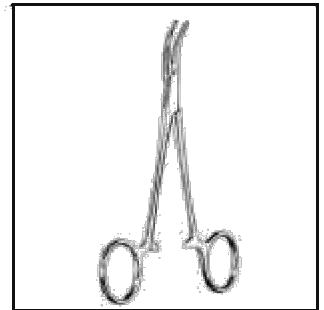

**BIS-384**  
Kilner Artery Forceps str 14cm

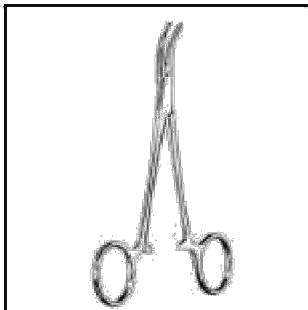

**BIS-385**  
Kilner Artery Forceps cvd  
14cm

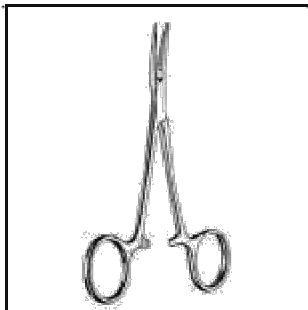

**BIS-386**  
Dunhill Artery Forceps cvd  
12.5cm



**BIS-387**  
Grey-Turner Artery Forceps  
str 15cm

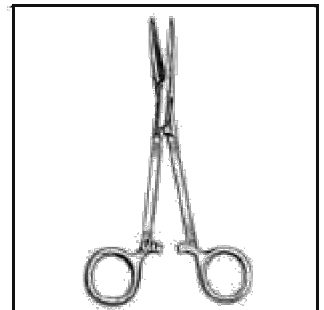

**BIS-388**  
Grey-Turner Artery Forceps  
cvd 15cm

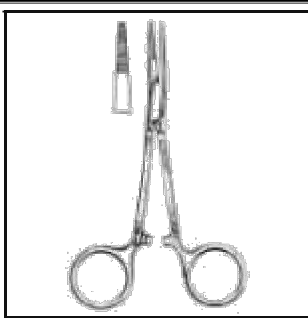

**BIS-389**  
Moynihans Artery Forceps str  
14.5cm



**BIS-390**  
Kocher Forceps Delicate str  
14cm



**BIS-391**  
Kocher Forceps Delicate cvd  
14cm

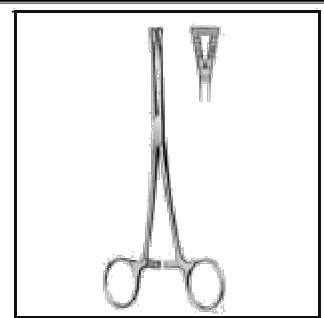

**BIS-392**  
Pennington Hemostatic  
Forceps 15.5cm

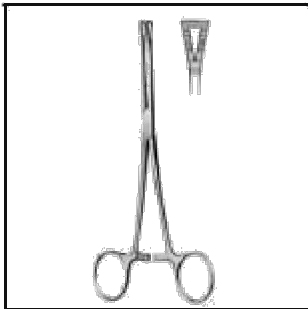

**BIS-393**  
Pennington Hemostatic  
Forceps 20cm

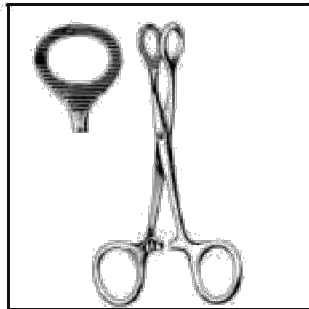

**BIS-394**  
Pean Hemostatic Forceps  
round jaw 12cm

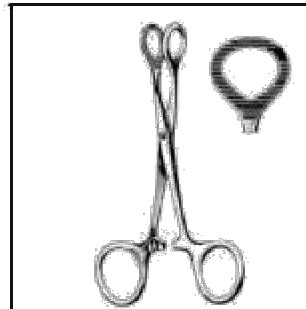

**BIS-395**  
Pean Hemostatic Forceps  
round jaw 12cm

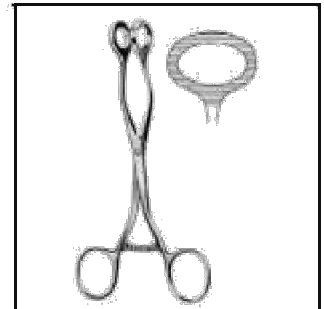

**BIS-396**  
Collin Hemostatic Forceps  
16cm

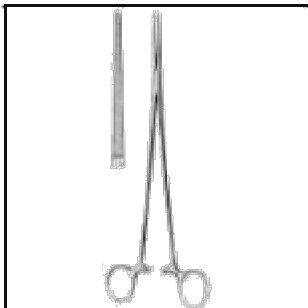

**BIS-397**  
Bengolea Hemostatic Forceps  
str serr 20cm

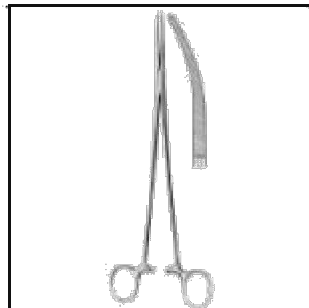

**BIS-398**  
Bengolea Hemostatic Forceps  
cvd serr 20cm

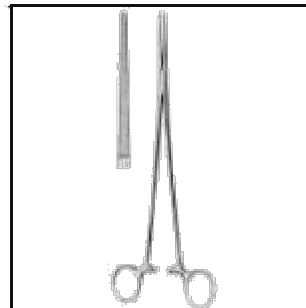

**BIS-399**  
Bengolea Hemostatic Forceps  
str serr 26cm

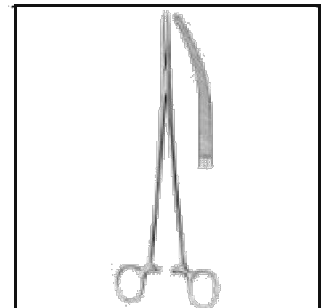

**BIS-400**  
Bengolea Hemostatic Forceps  
cvd serr 26cm

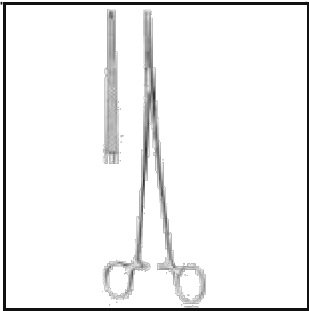

**BIS-401**  
Bengolea Hemostatic Forceps  
str 1x2T 20cm

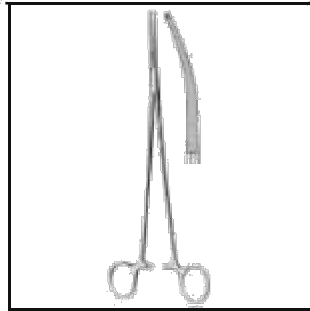

**BIS-402**  
Bengolea Hemostatic Forceps  
cvd 1x2T 20cm

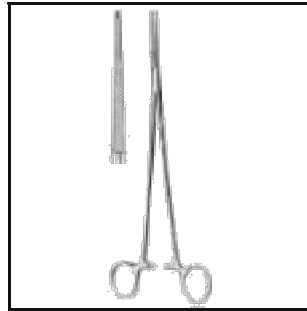

**BIS-403**  
Bengolea Hemostatic Forceps  
str 1x2T 26cm

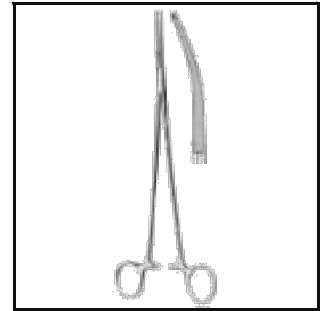

**BIS-404**  
Bengolea Hemostatic Forceps  
cvd 1x2T 26cm

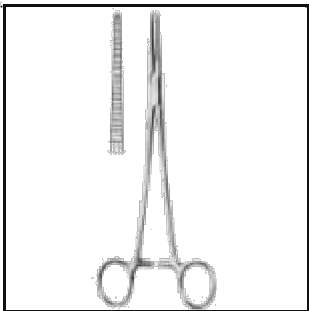

**BIS-405**  
Heiss Hemostatic Forceps str  
20cm

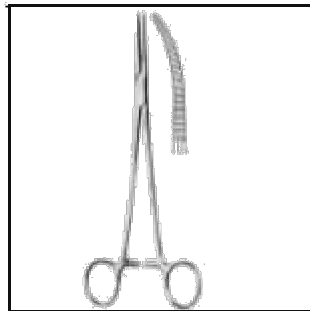

**BIS-406**  
Heiss Hemostatic Forceps half  
cvd 20cm

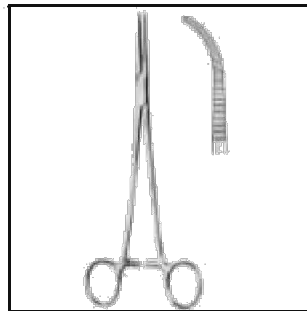

**BIS-407**  
Heiss Hemostatic Forceps full  
cvd 20cm

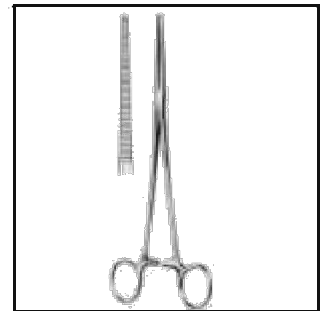

**BIS-408**  
Roberts Hemostatic Forceps  
str 22cm

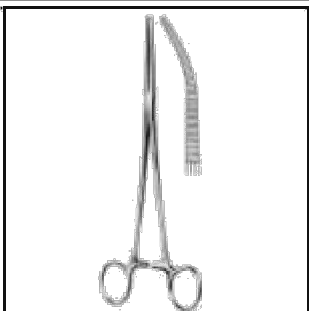

**BIS-409**  
Roberts Hemostatic Forceps  
cvd 22cm

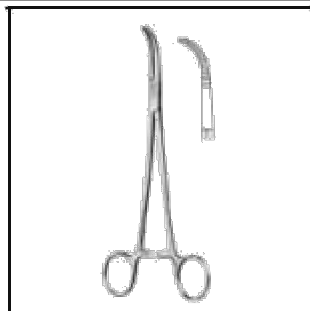

**BIS-410**  
Overholt-Geissendorfer  
Forceps 21cm Fig.1

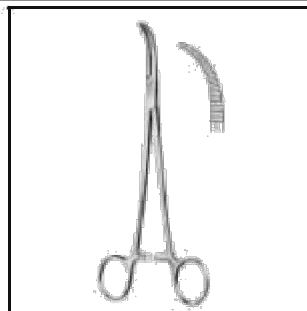

**BIS-411**  
Overholt-Geissendorfer  
Forceps 21cm Fig.2

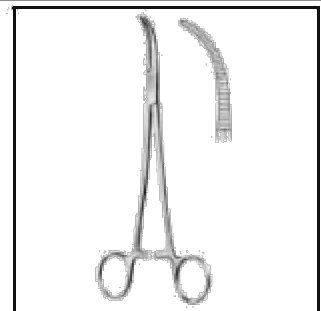

**BIS-412**  
Overholt-Geissendorfer  
Forceps 21cm Fig.3

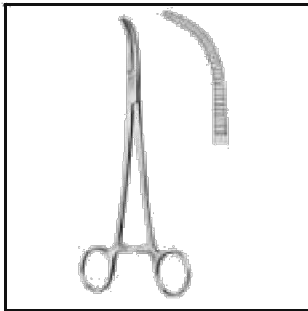

**BIS-413**  
Overholt-Geissendorfer  
Forceps 21cm Fig.4

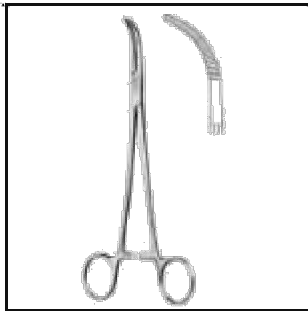

**BIS-414**  
Overholt-Geissendorfer  
Forceps 21cm Fig.5

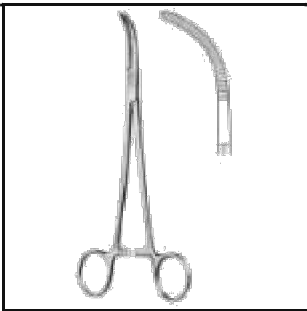

**BIS-415**  
Overholt-Geissendorfer  
Forceps 21cm Fig.6

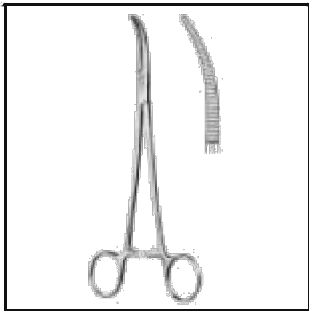

**BIS-416**  
Overholt-Geissendorfer  
Forceps 21cm Fig.7

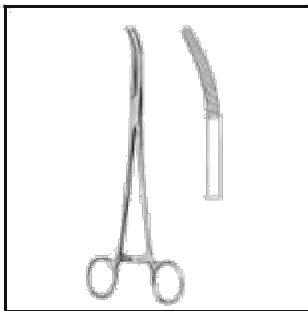

**BIS-417**  
Rumel Thorax Forceps slight  
cvd 23cm

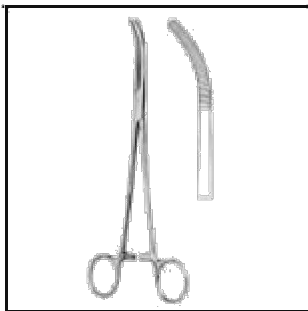

**BIS-418**  
Rumel Artery Forceps cvd  
23cm

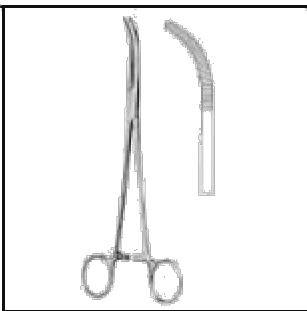

**BIS-419**  
Rumel Thorax Forceps semi  
cvd 23cm

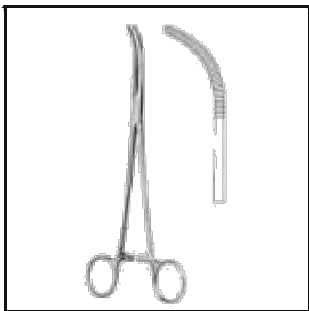

**BIS-420**  
Rumel Thorax Forceps half  
cvd 23cm

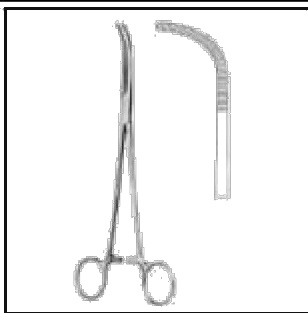

**BIS-421**  
Rumel Thorax Forceps full  
cvd 23cm

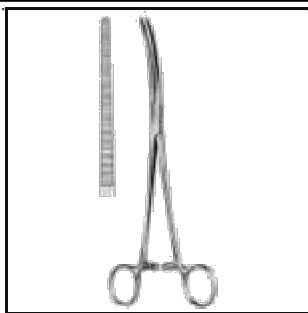

**BIS-422**  
Sarot Bronchus Clamp str  
24cm

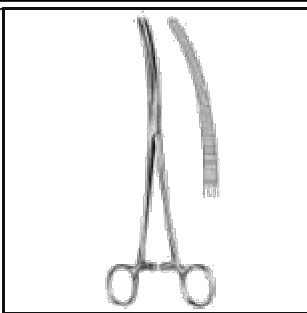

**BIS-423**  
Sarot Bronchus Clamp cvd  
24cm

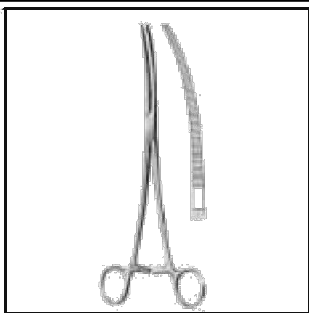

**BIS-424**  
Crafoord Bronchus Clamp cvd  
24cm



**BIS-425**  
Pratt Hemostatic Forceps str  
15cm

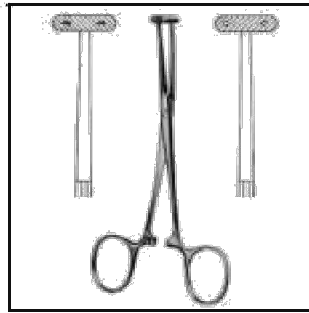

**BIS-426**  
Martel Scalp Flap Forceps  
14cm



**BIS-427**  
Willet Martel Scalp Flap  
Forceps 19cm

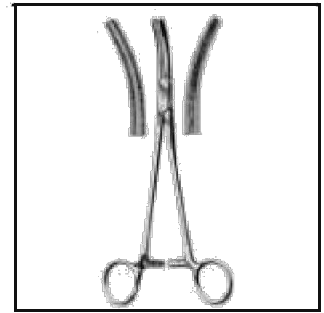

**BIS-428**  
Buie Angiotribe Forceps cvd  
21cm

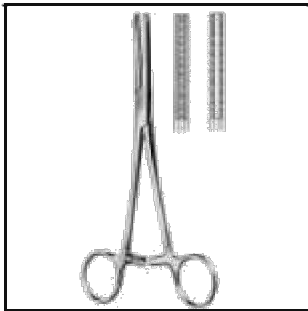

**BIS-429**  
Fergusson Angiotribe Forceps  
str 16cm

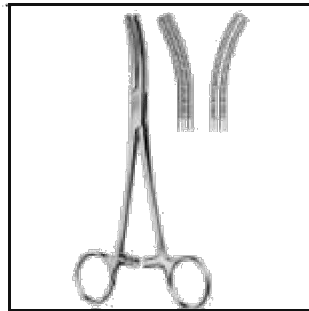

**BIS-430**  
Fergusson Angiotribe Forceps  
cvd 16cm



**BIS-431**  
Fergusson Angiotribe Forceps  
str 20cm

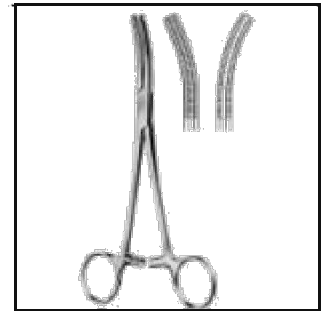

**BIS-432**  
Fergusson Angiotribe Forceps  
cvd 20cm

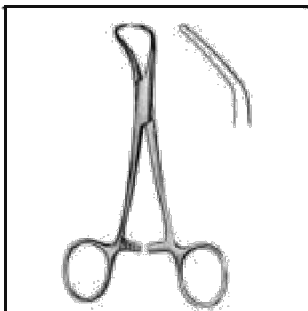

**BIS-433**  
Backhaus Towel Forceps  
9cm

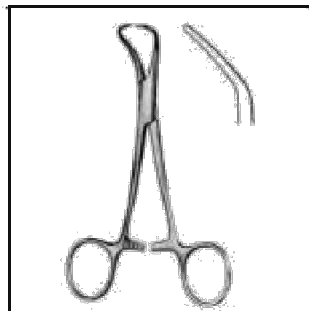

**BIS-434**  
Backhaus Towel Forceps  
11cm

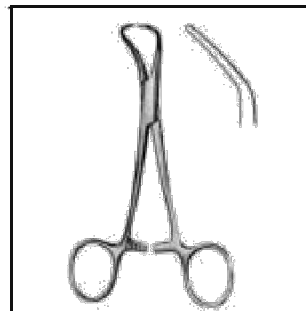

**BIS-435**  
Backhaus Towel Forceps  
13cm

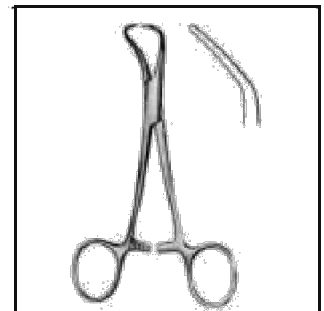

**BIS-436**  
Backhaus Towel Forceps  
15cm

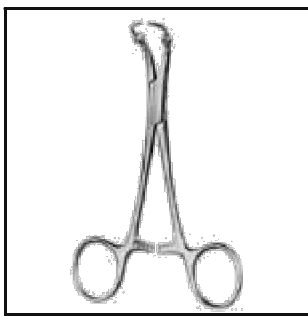

**BIS-437**  
Roeder Towel Forceps 13cm



**BIS-438**  
Roeder Towel Clamp 15cm

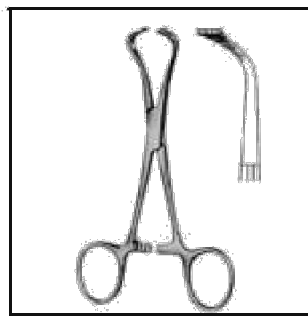

**BIS-439**  
Lorna Towel Forceps 10cm

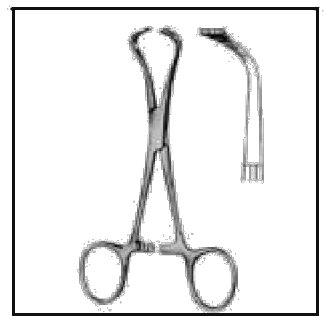

**BIS-440**  
Lorna Non Perforating Towel Forceps 13cm

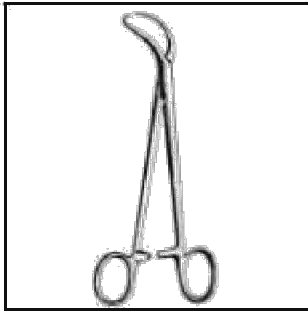

**BIS-441**  
Mayo Towel Clamp 14cm

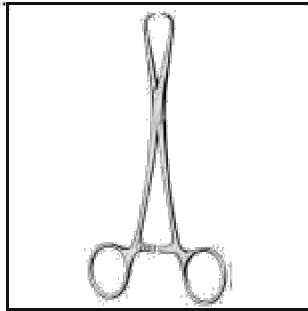

**BIS-442**  
Bernhard Towel Forceps 16cm

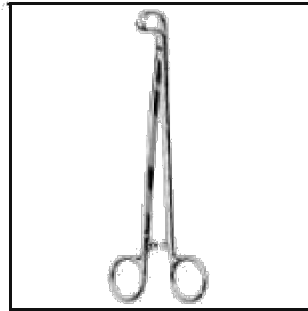

**BIS-443**  
Moynihan Towel Forceps 19cm

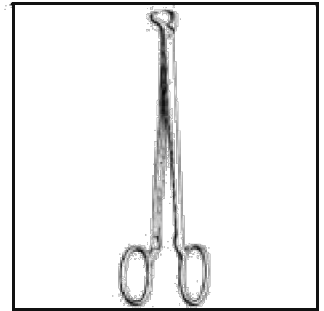

**BIS-444**  
Moynihan Towel Clamp 18cm

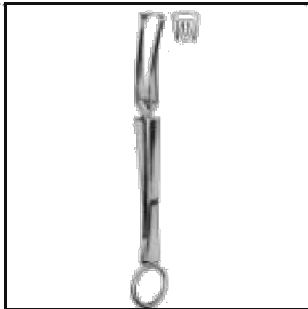

**BIS-445**  
Doyen Towel Forceps Ring 18cm



**BIS-446**  
Robin Anchoring Forceps  
13mm, 12.5cm

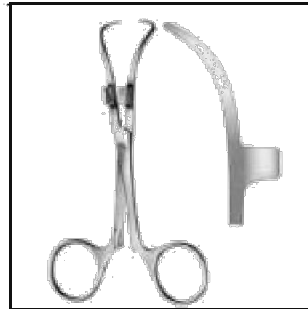

**BIS-447**  
Robin Anchoring Forceps  
13mm, 12.5cm



**BIS-448**  
Robin Anchoring Forceps  
25mm, 12.5cm



**BIS-449**  
Schaedel Towel Clip 9cm



**BIS-450**  
English Model Towel Clamp  
9cm



**BIS-451**  
Jones Towel Clamp 5cm



**BIS-452**  
Jones Towel Clip 9cm



**BIS-453**  
Klinikum Berlin Tubing Clamp  
serr jaws 14cm

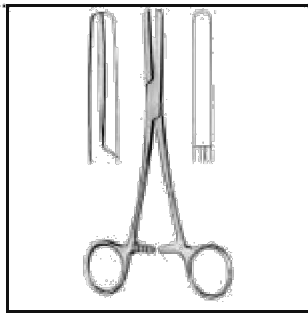

**BIS-454**  
Tube Occluding Forceps  
(Presbyterian Hosp.) 16cm

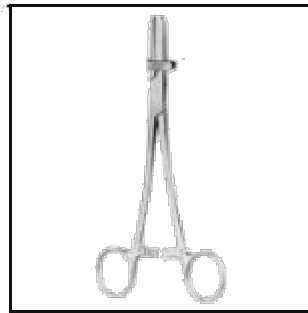

**BIS-455**  
USA Model Tubing Clamp  
c/serr w/clip 16.5cm

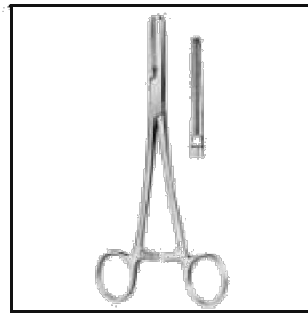

**BIS-456**  
USA Model/Murphy Tubing  
Clamp c/serr 15cm



**BIS-457**  
USA Model/Murphy Tubing  
Clamp c/serr 18cm





**BIS-458**  
Dressing Forceps (English  
patt.) T.O.E 12.5cm

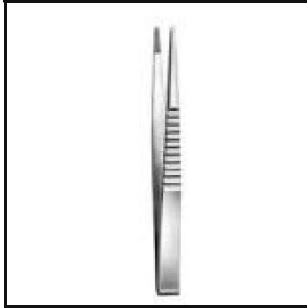

**BIS-459**  
Dressing Forceps (English  
patt.) T.O.E 15cm

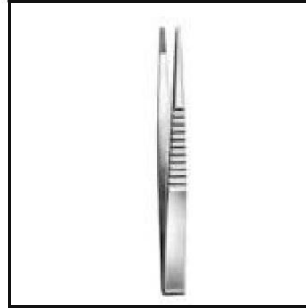

**BIS-460**  
Dressing Forceps (English  
patt.) T.O.E 18cm

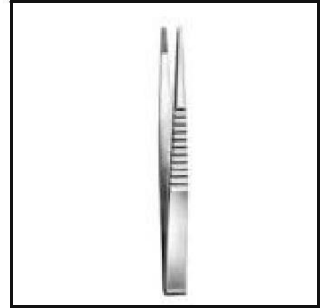

**BIS-461**  
Dressing Forceps (English  
patt.) T.O.E 20cm



**BIS-462**  
Dressing Forceps (English  
patt.) T.O.E 25cm



**BIS-463**  
Dressing Forceps (English  
patt.) B/E 12.5cm



**BIS-464**  
Dressing Forceps (English  
patt.) B/E 15cm



**BIS-465**  
Dressing Forceps (English  
patt.) B/E 18cm



**BIS-466**  
Dressing Forceps (English  
patt.) B/E 20cm



**BIS-467**  
Dressing Forceps (English  
patt.) B/E 25cm

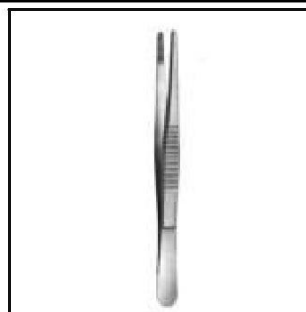

**BIS-468**  
Thumb Dissecting Forceps  
serr 10cm

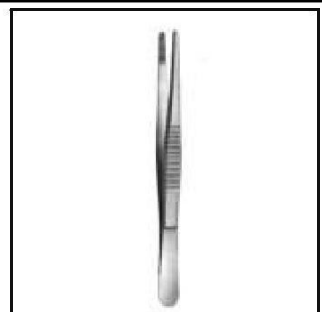

**BIS-469**  
Standard Dressing Forceps  
11.5cm

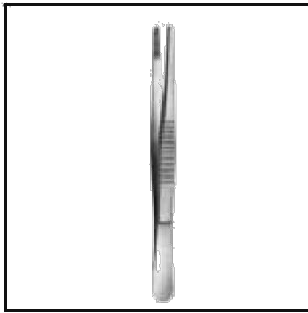

**BIS-470**  
Standard Dressing Forceps  
serr 13cm

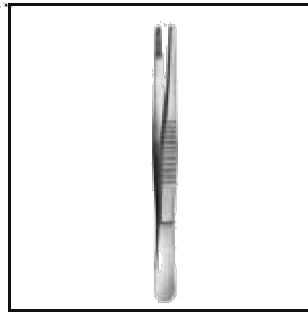

**BIS-471**  
Standard Dressing Forceps  
serr 14.5cm

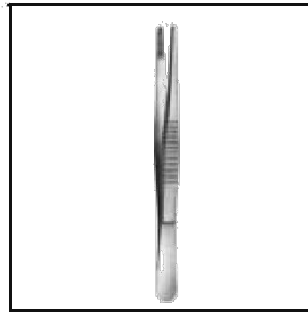

**BIS-472**  
Standard Dressing Forceps  
serr 16cm

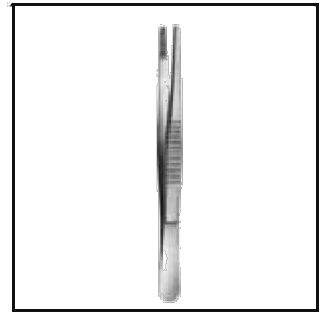

**BIS-473**  
Standard Dressing Forceps  
serr 18cm

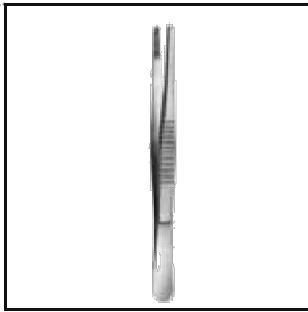

**BIS-474**  
Standard Dressing Forceps  
serr 20cm

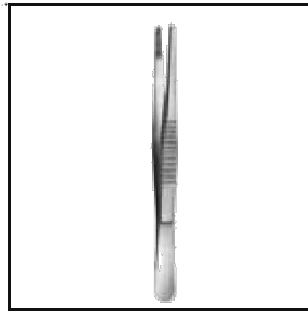

**BIS-475**  
Standard Dressing Forceps  
serr 25cm

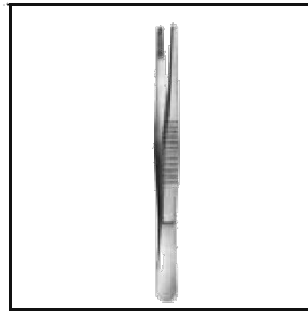

**BIS-476**  
Standard Dressing Forceps  
serr 30cm

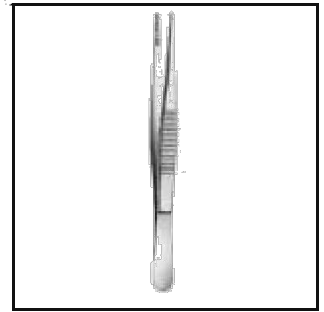

**BIS-477**  
Dressing Forceps Narrow Tip  
13cm

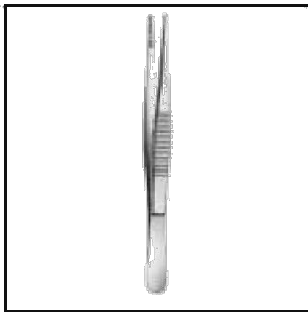

**BIS-478**  
Dressing Forceps Narrow Tip  
14.5cm

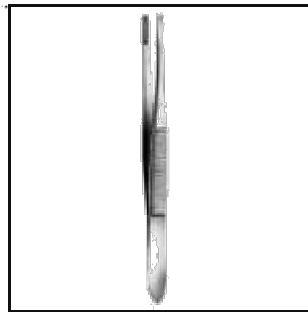

**BIS-479**  
Stille Dressing Forceps serr  
Swedish patt. 15cm

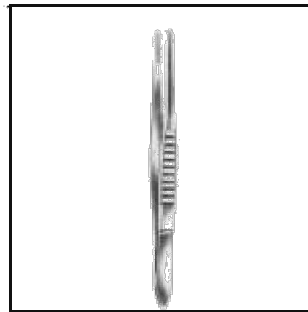

**BIS-480**  
Dressing Forceps USA model  
12cm

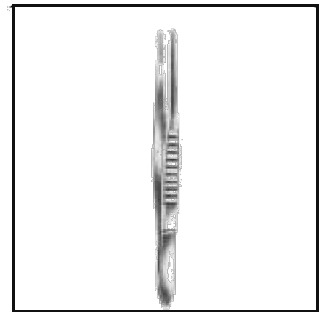

**BIS-481**  
Dressing Forceps USA model  
14cm

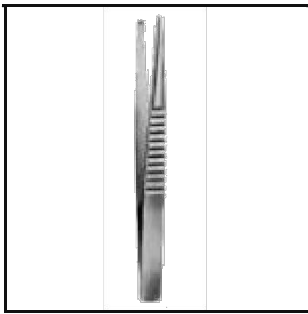

**BIS-482**  
Treves Tissue Forceps  
(English pat.) 1x2T, 18cm

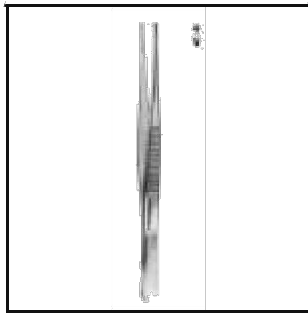

**BIS-483**  
Standard Tissue Forceps  
1x2T, 10cm

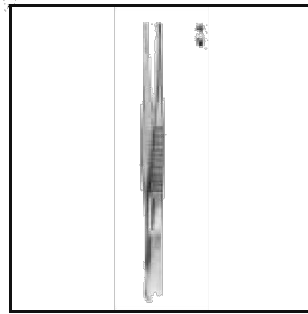

**BIS-484**  
Standard Tissue Forceps  
1x2T 11.5cm

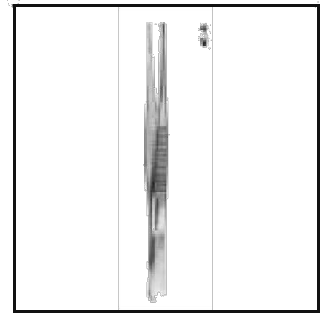

**BIS-485**  
Standard Tissue Forceps  
1x2T 13cm

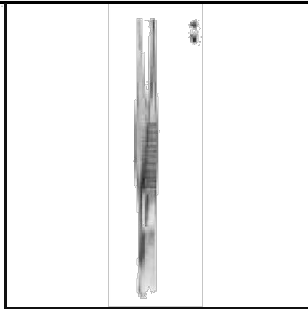

**BIS-486**  
Standard Tissue Forceps  
1x2T 14.5cm

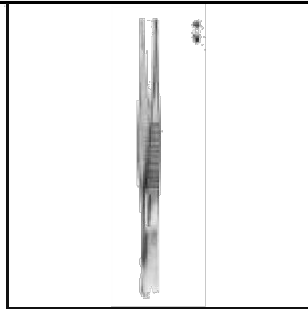

**BIS-487**  
Standard Tissue Forceps  
1x2T 16cm

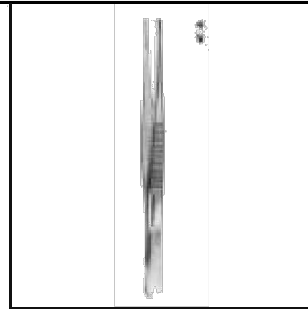

**BIS-488**  
Standard Tissue Forceps  
1x2T 18cm

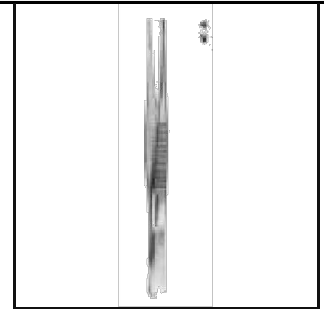

**BIS-489**  
Standard Tissue Forceps  
1x2T 20cm

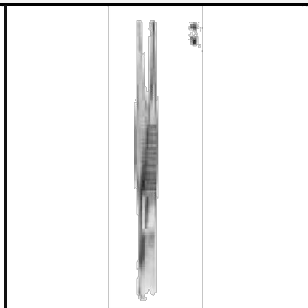

**BIS-490**  
Standard Tissue Forceps  
1x2T 25cm

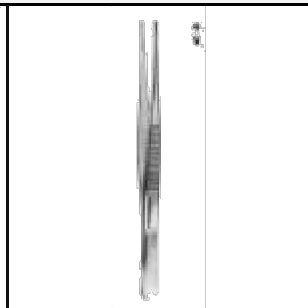

**BIS-491**  
Standard Tissue Forceps  
1x2T 30cm

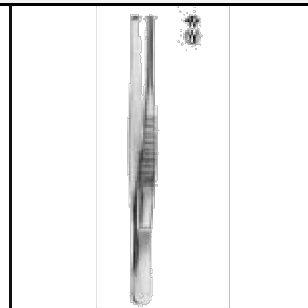

**BIS-492**  
Tissue Forceps 2x3T 10cm

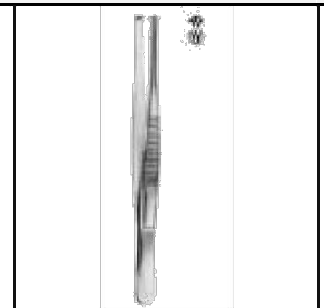

**BIS-493**  
Tissue Forceps 2x3T, 11.5cm

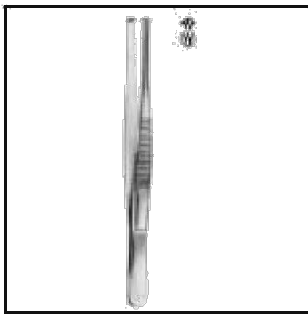

**BIS-494**  
Tissue Forceps 2x3T 13cm

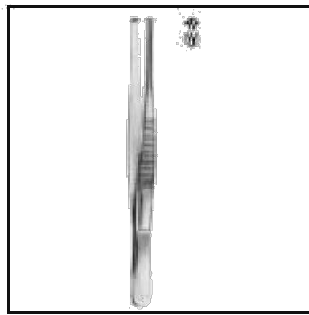

**BIS-495**  
Tissue Forceps 2x3T 14cm

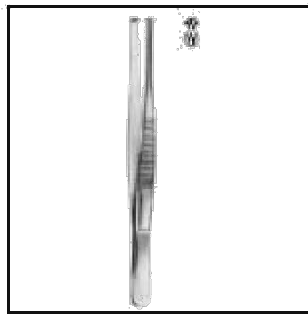

**BIS-496**  
Tissue Forceps 2x3T 16cm

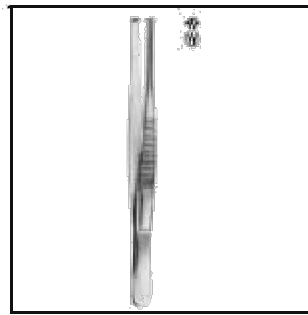

**BIS-497**  
Tissue Forceps 2x3T 18cm



**BIS-498**  
Tissue Forceps 2x3T 20cm

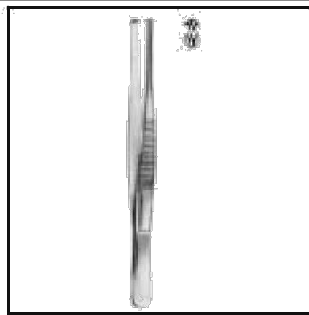

**BIS-499**  
Tissue Forceps 2x3T 25cm



**BIS-500**  
Tissue Forceps 2x3T 30cm

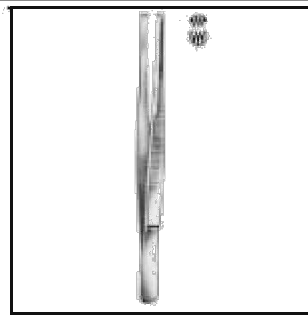

**BIS-501**  
Tissue Forceps 3x4T 13cm

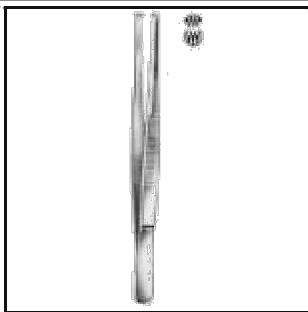

**BIS-502**  
Tissue Forceps 3x4T 14.5cm

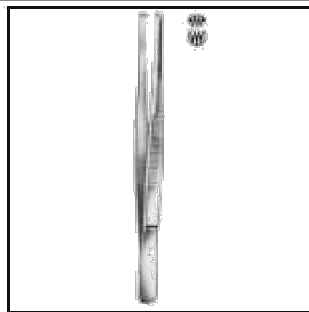

**BIS-503**  
Tissue Forceps 3x4T 16cm

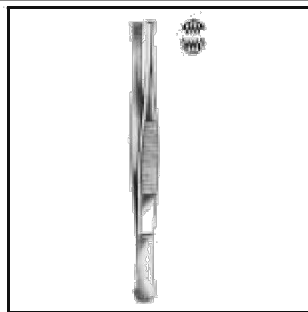

**BIS-504**  
Tissue Forceps 4x5T 13cm

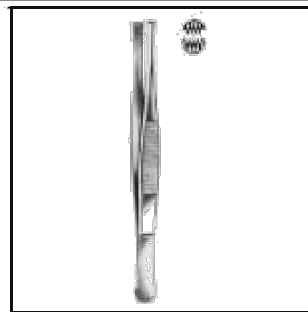

**BIS-505**  
Tissue Forceps 4x5T 14.5cm

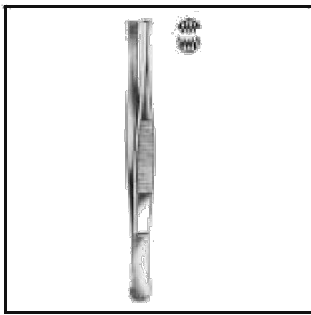

**BIS-506**  
Tissue Forceps 4x5T 16cm

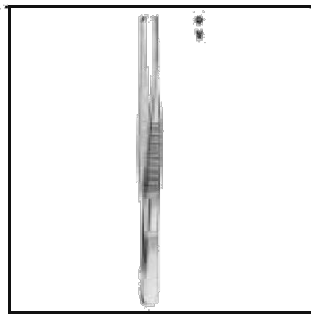

**BIS-507**  
Tissue Forceps 1x2T Narrow  
13cm

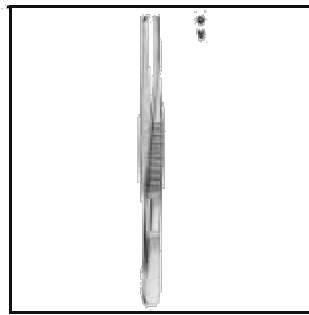

**BIS-508**  
Tissue Forceps 1x2T Narrow  
14.5cm

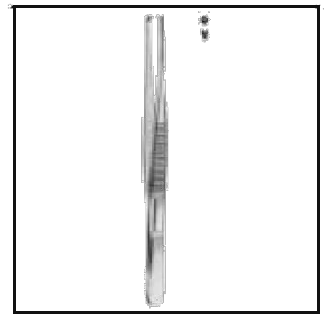

**BIS-509**  
Tissue Forceps 1x2T Narrow  
16cm

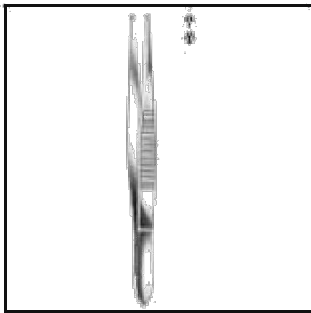

**BIS-510**  
Stille Tissue Forceps 1x2T  
15cm

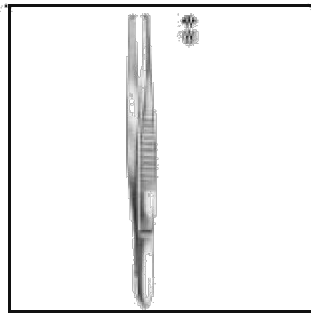

**BIS-511**  
Stille Tissue Forceps 2x3T  
15cm

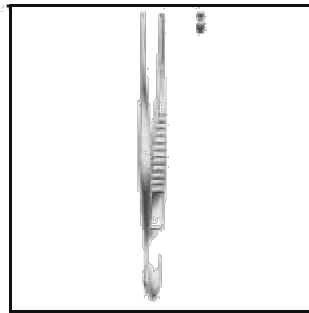

**BIS-512**  
Tissue Forceps USA model  
1x2T 12cm

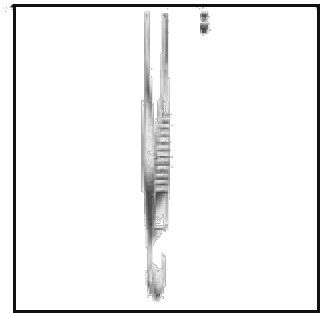

**BIS-513**  
Tissue Forceps USA model  
1x2T 13cm

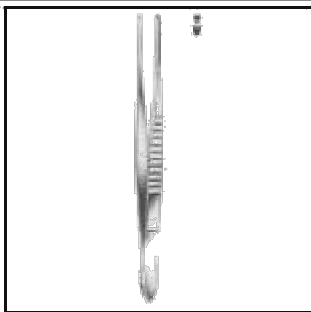

**BIS-514**  
Tissue Forceps USA model  
1x2T 14.5cm

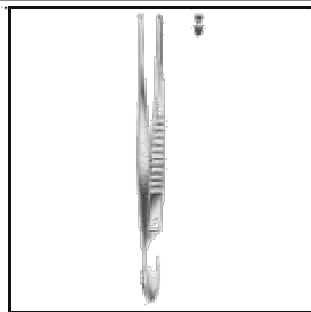

**BIS-515**  
Tissue Forceps USA model  
1x2T 15.5cm

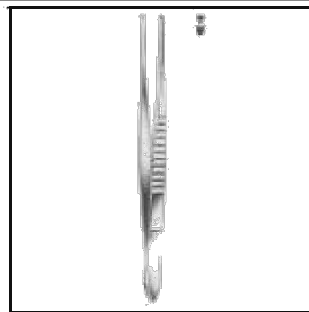

**BIS-516**  
Tissue Forceps USA model  
1x2T 18.5cm

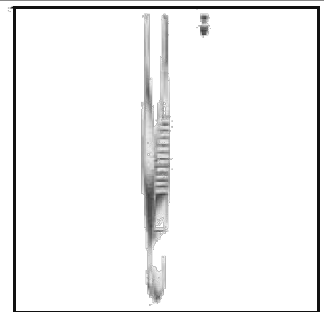

**BIS-517**  
Tissue Forceps USA model  
1x2T 21cm

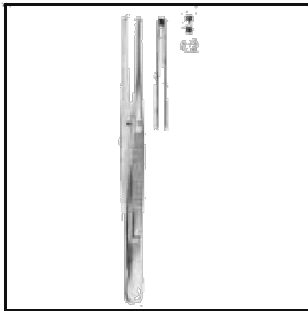

**BIS-518**  
Semken Forceps 1x2T  
12.5cm

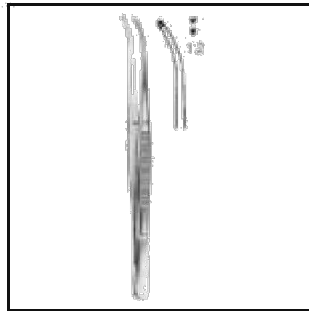

**BIS-519**  
Semken Tissue Forceps 1x2T  
cvd 12.5cm

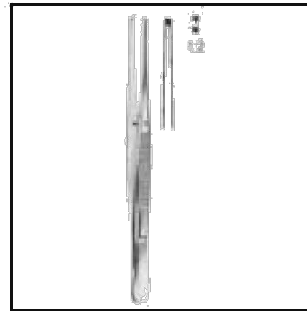

**BIS-520**  
Semken Tissue Forceps 1x2T  
15cm

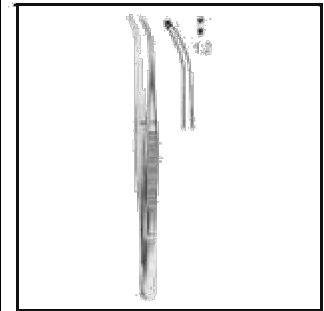

**BIS-521**  
Semken Tissue Forceps 1x2T  
cvd 15cm

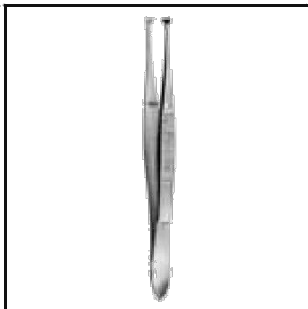

**BIS-522**  
Graefe Tissue Forceps 10cm

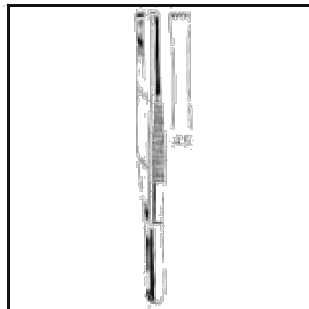

**BIS-523**  
Stone Tissue Forceps 4x5T  
15cm

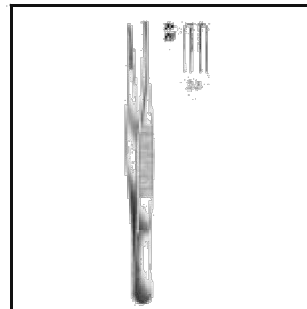

**BIS-524**  
Adlerkreutz Tissue Forceps  
2x3T, 15cm

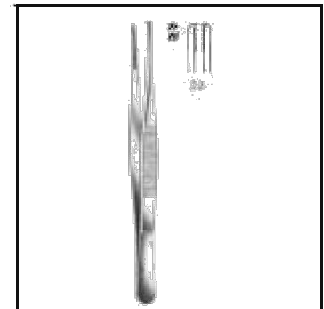

**BIS-525**  
Adlerkreutz Tissue Forceps  
2x3T, 20cm

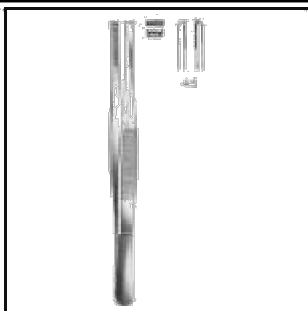

**BIS-526**  
Adlerkreutz Forceps 4x5T  
15cm

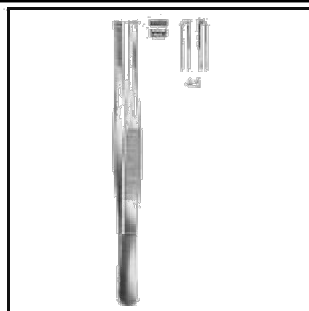

**BIS-527**  
Adlerkreutz Forceps 4x5T  
20cm

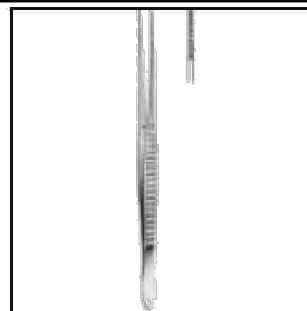

**BIS-528**  
Waugh Dressing Forceps criss  
cross serr 20cm

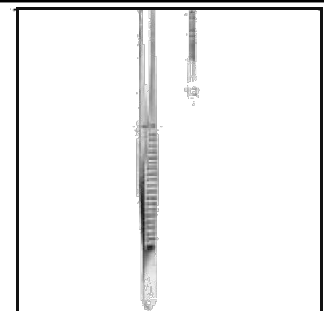

**BIS-529**  
Waugh Tissue Forceps criss  
cross serr 1x2T 20cm

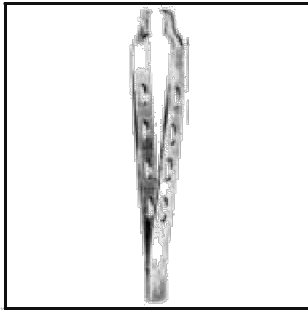

**BIS-530**  
Jeans Tissue Forceps 1x2T  
14.5cm

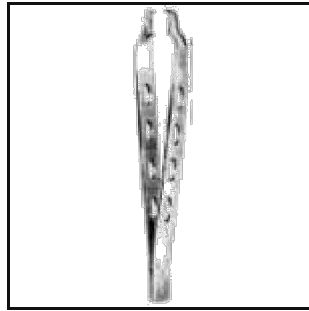

**BIS-531**  
Jeans Tissue Forceps 1x2T  
17.5cm

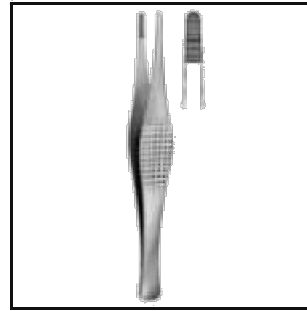

**BIS-532**  
Ramsay Dressing Forceps  
serr 18cm

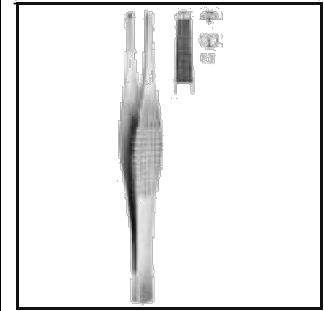

**BIS-533**  
Ramsay Tissue Forceps 1x2T,  
18cm

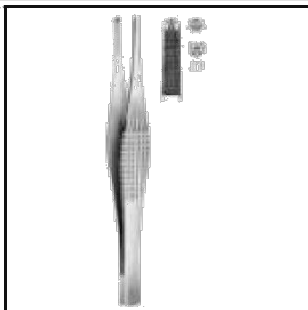

**BIS-534**  
Ramsay Tissue Forceps 2x3T,  
18cm

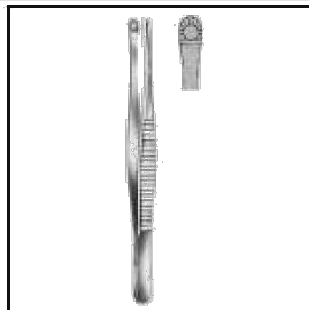

**BIS-535**  
Russian Pattern Tissue  
Forceps 15cm

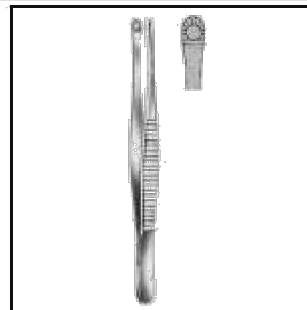

**UEI-1521 BIS-536**  
Pattern Tissue Forceps 20cm

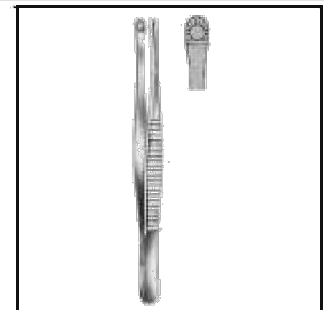

**BIS-537**  
Russian Pattern Tissue  
Forceps 25cm

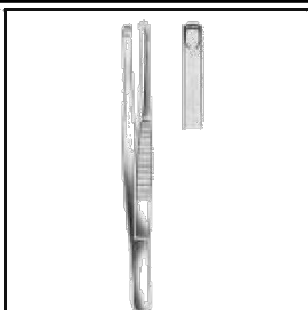

**BIS-538**  
Durante Tissue Forceps  
14.5cm

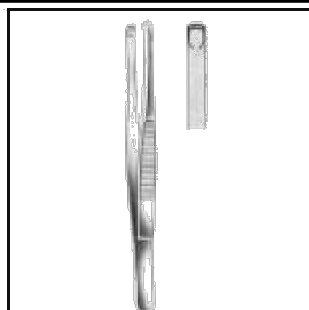

**BIS-539**  
Durante Tissue Forceps  
16cm

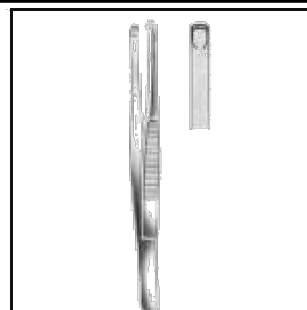

**BIS-540**  
Durante Tissue Forceps  
20cm

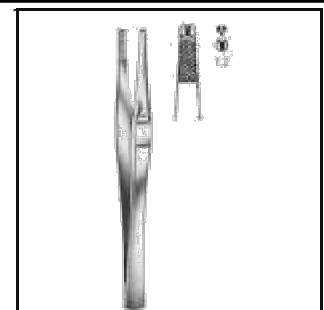

**BIS-541**  
Lanes Tissue Forceps 1x2T  
12.5cm

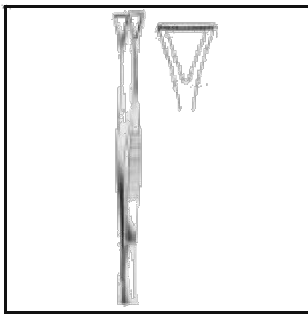

**BIS-542**  
Collin Duval Tissue Forceps  
18mm jaws 20cm

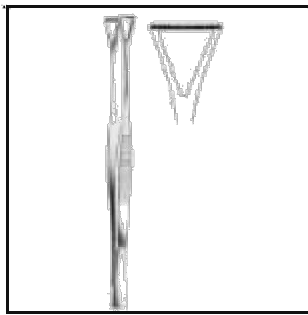

**BIS-543**  
Collin Duval Tissue Forceps  
27mm jaws 20cm

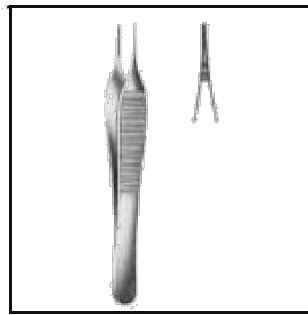

**BIS-544**  
Adson Micro Forceps serr  
12cm

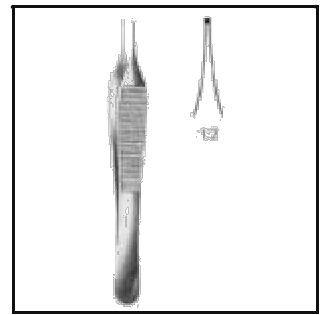

**BIS-545**  
Adson Micro Tissue Forceps  
1x2T 12cm

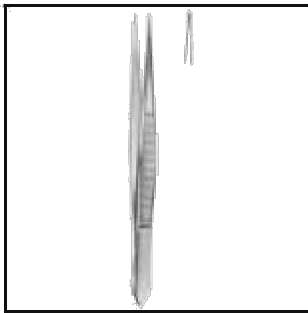

**BIS-546**  
Micro Forceps smooth str  
9cm

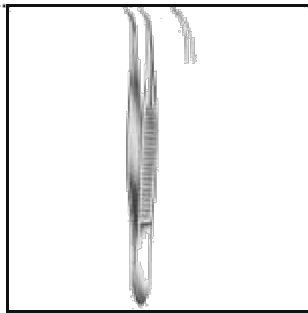

**BIS-547**  
Micro Forceps smooth cvd  
9cm

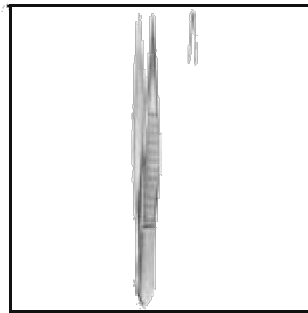

**BIS-548**  
Micro Forceps smooth str  
10.5cm

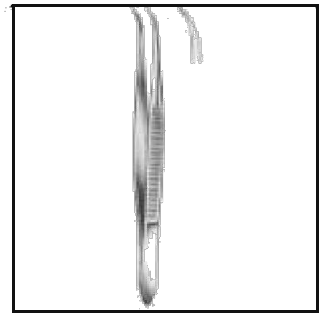

**BIS-549**  
Micro Forceps smooth cvd  
10.5cm

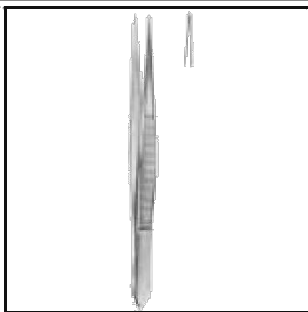

**BIS-550**  
Micro Forceps smooth str  
11.5cm

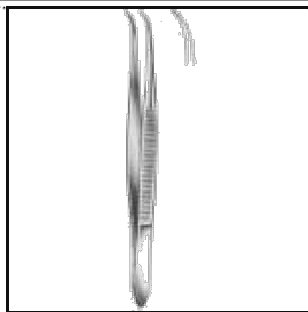

**BIS-551**  
Micro Forceps smooth cvd  
11.5cm

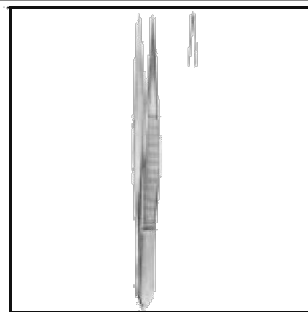

**BIS-552**  
Micro Forceps smooth str  
12.5cm

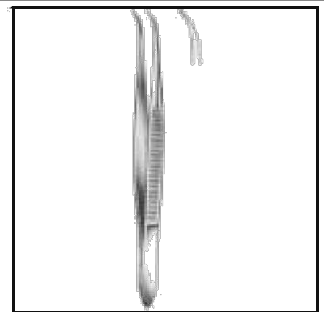

**BIS-553**  
Micro Forceps smooth cvd  
12.5cm



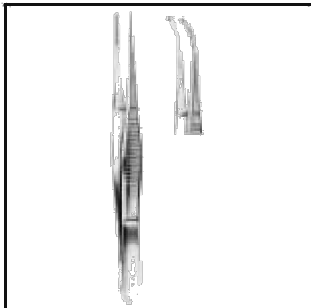

**BIS-554**  
Fine Tissue Forceps 1x2T  
semi cvd 10.5cm

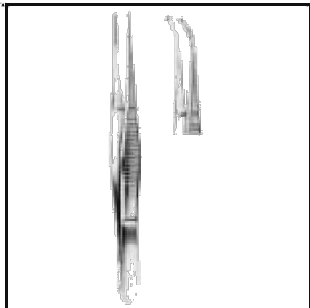

**BIS-555**  
Fine Tissue Forceps 1x2T Full  
cvd 10.5cm

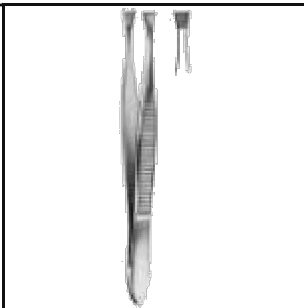

**BIS-556**  
Littauer Cilia Forceps 8.5cm

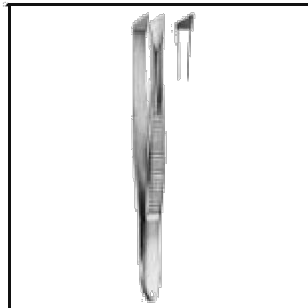

**BIS-557**  
Bergh Cilia Forceps oblique  
9cm

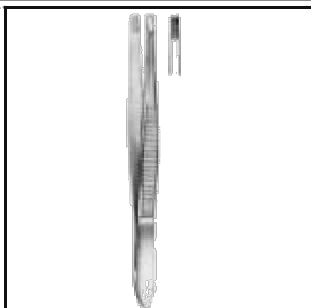

**BIS-558**  
Douglas Cilia Forceps broad  
tip 9cm

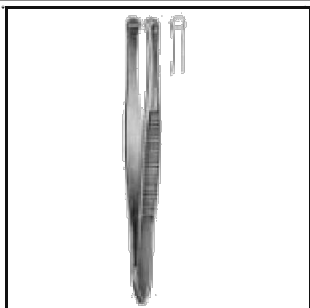

**BIS-559**  
Beer Cilia Forceps 9cm

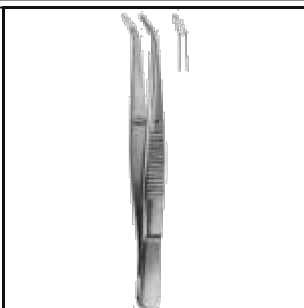

**BIS-560**  
Barraquer Cilia Forceps  
10.5cm

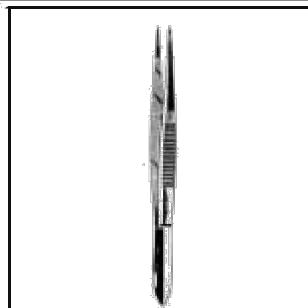

**BIS-561**  
Splinter Forceps guide  
pin 10.5cm

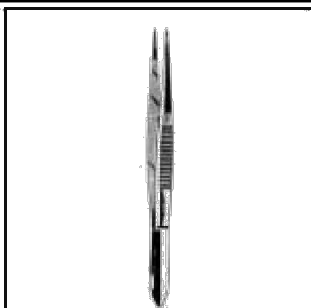

**BIS-562**  
Splinter Forceps guide  
pin 12.5cm

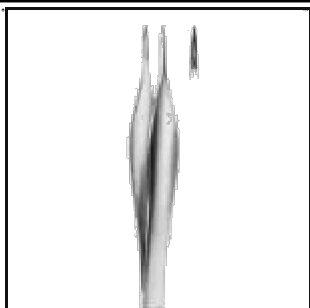

**BIS-563**  
Feilchenfeld Splinter Forceps  
7.5cm

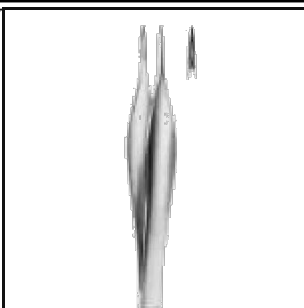

**BIS-564**  
Feilchenfeld Splinter Forceps  
9cm

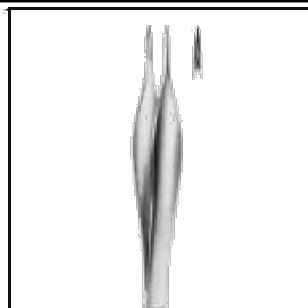

**BIS-565**  
Feilchenfeld Splinter Forceps  
11.5cm

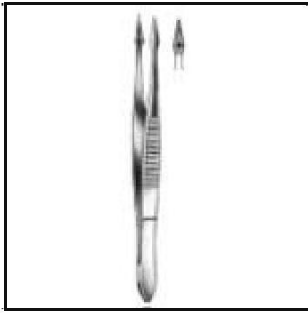

**BIS-566**  
Hunter Splinter Forceps str  
10.5cm



**BIS-567**  
Hunter Splinter Forceps cvd  
10.5cm

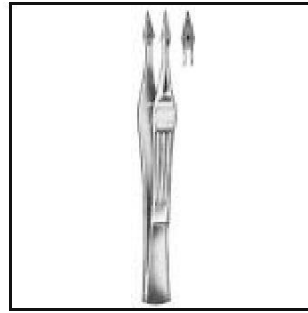

**BIS-568**  
Walter Carmalt Splinter  
Forceps str 10.5cm



**BIS-569**  
Walter Carmalt Splinter  
Forceps cvd 10.5cm



**BIS-570**  
Splinter Forceps w/Magnifier  
12cm



**BIS-571**  
Peet Splinter Forceps serr  
jaws 11.5cm

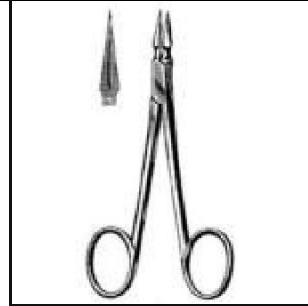

**BIS-572**  
Arther Splinter Forceps 14cm



**BIS-573**  
Arther Splinter Forceps 14cm



**BIS-574**  
Stieglitz Splinter Forceps  
14cm



**BIS-575**  
Stieglitz Splinter Forceps  
angled 45°, 14cm

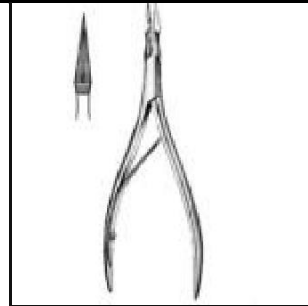

**BIS-576**  
Virtus (Ralk) Splinter Forceps  
str 15cm

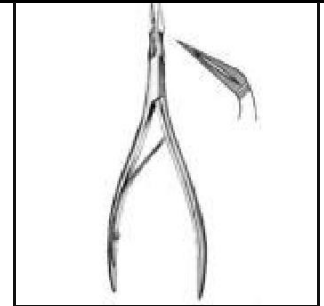

**BIS-577**  
Virtus (Ralk) Splinter Forceps  
cvd 15cm

# MAX<sup>®</sup>

## PROFESSIONAL



Registration No. A428

Registration No. A-28828



+92-321-4110689



amaxprofessional



amaxprofessional



info@amaxprofessional.com



www.amaxprofessional.com



Factory Address: 8 Rorass Road Muzaffar Pur  
Small industrial Area Sialkot Punjab Pakistan

Amax Professional

**NTN**=3606433-5

**Trade mark Registration No:**

Pakistan : 541973

Argentina: 3.176.543 , 3.176.545